



ID ISC.ANT1710/690 Crystal Gate Type A and B



Note

© Copyright 2018 by
FEIG ELECTRONIC GmbH
Lange Strasse 4
D-35781 Weilburg
Tel.: +49 6471 3109-0
<http://www.feig.de>

With the edition of this document, all previous editions become void. Indications made in this manual may be changed without previous notice.

Copying of this document, and giving it to others and the use or communication of the contents thereof are forbidden without express authority. Offenders are liable to the payment of damages. All rights are reserved in the event of the grant of a patent or the registration of a utility model or design.

Composition of the information in this document has been done to the best of our knowledge. FEIG ELECTRONIC GmbH does not guarantee the correctness and completeness of the details given in this manual and may not be held liable for damages ensuing from incorrect or incomplete information. Since, despite all our efforts, errors may not be completely avoided, we are always grateful for your useful tips.

The instructions given in this manual are based on advantageous boundary conditions. FEIG ELECTRONIC GmbH does not give any guarantee promise for perfect function in cross environments and does not give any guaranty for the functionality of the complete system which incorporates the subject of this document.

FEIG ELECTRONIC call explicit attention that devices which are subject of this document are not designed with components and testing methods for a level of reliability suitable for use in or in connection with surgical implants or as critical components in any life support systems whose failure to perform can reasonably be expected to cause significant injury to a human. To avoid damage, injury, or death, the user or application designer must take reasonably prudent steps to protect against system failures.

FEIG ELECTRONIC GmbH assumes no responsibility for the use of any information contained in this document and makes no representation that they free of patent infringement. FEIG ELECTRONIC GmbH does not convey any license under its patent rights nor the rights of others.

OBID[®] and OBID i-scan[®] are registered trademarks of FEIG ELECTRONIC GmbH.

my-d[®] is a registered trademark of Infineon Technologies AG

I-CODE[®] is a registered trademark of Philips Electronics N.V.

Tag-it[™] is a registered trademark of Texas Instruments Incorporated.

General information's regarding this document

- The sign "☞" indicates extensions or changes of this manual compared with the former issue.
- If bits within one byte are filled with "-", these bit spaces are reserved for future extensions or for internal testing- and manufacturing-functions. These bit spaces must not be changed, as this may cause faulty operation of the reader.
- The following figure formats are used:
0...9: for decimal figures
0x00...0xFF: for hexadecimal figures,
b0...1 for binary figures.
- The hexadecimal value in brackets "[]" marks a control byte (command).

Contents

<hr/>	
ID ISC.ANT1710/690 Crystal Gate Type A and B	1
1 Safety Instructions / Warning - Read before Start-Up !	5
2 Instruction on transportation and shipping of the antennas	6
3 Maintenance	7
4 Performance Features	8
<hr/>	
4.1 Scope of delivery	8
4.1.1 Antenna ID ISC.ANT1710/690-A Crystal Gate Type A	8
4.1.2 Antenna ID ISC.ANT1710/690-B Crystal Gate Type B	8
4.2 Performance Features of the ID ISC.ANT1710/690 Crystal Gate Antennas	8
4.3 Performance Features of the People Counter (ID ISC.ANT.GPC).....	9
4.4 Available Antenna Types	11
<hr/>	
5 Installation and Wiring	12
<hr/>	
5.1 Mounting Preparation.....	13
5.2 Installing the antenna.....	14
5.2.1 Dimensions of antenna.....	14
5.2.2 Drilling the Mounting Holes	15
5.2.3 Installing the Antenna Base and Antenna Body.....	17
<hr/>	
6 Typical Antenna Configuration (Gate Antenna with two Antennas)	18
<hr/>	
6.1 Project Notes Antenna	18
6.2 Project Notes People Counter (GPC)	21
6.3 Project Notes People Counter Direction Detection Mode.....	23
6.4 Gate Configuration and Setup using Antennas.....	23
6.4.1 Required Components	23
6.4.2 Configuration of a Gate Antenna with Multiplexer	24
6.4.3 Setting the Multiplexer.....	29
6.4.4 Setting the Antenna Tuner	30
6.4.5 Interface Connections	31
6.4.5.1 LAN / TCP/IP	31
6.4.6 Reader Configuration with Multiplexer	32
6.4.7 Tuning the Gate Antenna	35
6.5 Testing the Gate Antenna.....	36

6.5.1	Checking the Noise Level.....	36
6.5.2	Reading a Serial Number	38
6.5.3	Testing the performance	39
6.6	Setting the Alarm Indicators (Alarm sounder and Alarm LED lights)	41
6.6.1	Setting the Buzzer.....	41
6.6.2	Setting the LED´s.....	42
6.6.3	Reader Setting for Alarm Indicators.....	43
6.6.4	Programming a Transponder with the AFI Byte.....	45
6.7	Activating the Automatic Mode.....	46
6.8	Automatic Bus addressing.....	47
6.9	Installation ID ISC.ANT.GPC-E2.....	48
7	Installation of the Gate People Counter ID ISC.ANT.GPC in antenna Type B	50
7.1	Installation and Connections	50
7.2	Configuration and Test.....	57
7.2.1	Connecting several People Counter	57
7.2.2	Configuration and Test in ISO-Host or Buffered Read Mode	58
7.2.3	Configuration and Test in Notification Mode	62
7.2.4	Using the trigger function of the Gate People Counter.....	64
7.2.5	Using the direction detection of transponder with the People Counter.....	66
7.2.6	Detection Area of Direction Mode.....	67
8	Configure the reader in accordance with national RF regulations	68
9	Technical Data	69
9.1	Antenna ID ISC.ANT1710/690 Crystal Gate Type A and B.....	69
9.2	People Counter ID ISC.ANT.GPC and ID ISC.ANT.GPC-E2.....	72
9.3	Approvals	73
9.3.1	Europe (CE)	73
9.3.1.1	Antenne ID ISC.ANT1710/690 Crystal Gate.....	73
9.3.1.2	People Counter ID ISC.ANT.GPC.....	73
9.3.2	USA (FCC) and Canada (IC).....	74
9.3.2.1	Antenna ID ISC.ANT1710/690 Crystal Gate.....	74
9.3.2.2	People Counter ID ISC.ANT.GPC.....	75
9.3.3	USA and Canada (UL)	75
10	Annex A	76
10.1	Terminal assignment “Terminal Board”.....	76
10.2	Internal wiring	77

1 Safety Instructions / Warning - Read before Start-Up !

- The device may only be used for the intended purpose designed by for the manufacturer.
- The operation manual should be conveniently kept available at all times for each user.
- Unauthorized changes and the use of spare parts and additional devices which have not been sold or recommended by the manufacturer may cause fire, electric shocks or injuries. Such unauthorized measures shall exclude any liability by the manufacturer.
- The liability-prescriptions of the manufacturer in the issue valid at the time of purchase are valid for the device. The manufacturer shall not be held legally responsible for inaccuracies, errors, or omissions in the manual or automatically set parameters for a device or for an incorrect application of a device.
- Repairs may only be executed by the manufacturer.
- Installation, operation, and maintenance procedures should only be carried out by qualified personnel.
- Use of the device and its installation must be in accordance with national legal requirements and local electrical codes .
 - When working on devices the valid safety regulations must be observed.
- Please observe that some parts of the device may heat severely.
- Before touching the device, the power supply must always be interrupted. Make sure that the device is without voltage by measuring. The fading of an operation control (LED) is no indicator for an interrupted power supply or the device being out of voltage!
- For installation and dismantling you should wear suitable safety gloves, because parts of antenna housing could be sharp-edged.



CAUTION! The Antenna-Tuner and the Antenna conductor carry voltages up to 1000V.



The Antenna is not water proof and should not be exposed to rain or humidity.

Under extreme circumstances water could seep into the antenna and damage the electronic circuits.

Special advice for wearers of cardiac pacemakers:

- Although this device doesn't exceed the valid limits for electromagnetic fields you should keep a minimum distance of 25 cm between the device and your cardiac pacemaker and not stay in an immediate proximity of the reader's antennas for any length of time.



- **CAUTION! Do not look directly into the Alarm LED light. There is a danger of injury of the eyes!**

2 Instruction on transportation and shipping of the antennas

The packaging of the antennas has been designed to transport antennas vertically standing on a pallet to the site of installation.



Attention! The antenna has be transported vertically on the **base side** on the pallet. A transporting or storing in the false orientation can cause damaging at the antenna.

In case a vertically positioned transport is not possible, the antenna can be transported lying on the narrow side. A transporting lying on its wide /flat side of the packaging can cause damage to the device.

The pallet has to be adapted to the size and the number of antennas. In no case shall the packaging stand out of the range. An additional protection of the edges of the pallet is recommended.

The packaging mustn't be moist at all times. When transporting overseas by ship or plane, the packaging has to be protected against get damp at any time.

Temperatures above or below the specified temperature range may damage the antenna and / or the packaging.

Any mechanical stress on the packaging is not permitted. Any stacking of packaging, can cause damaging in the packaging below.

Even after the unpacking of the antennas the face of the antenna plate must be always transported and stored vertically. A transport in horizontally oriented antenna can deform the antenna plate.



3 Maintenance

The antenna ID ISC.ANT1710/690 Crystal Gate is a design product with high quality surfaces, and should always be handled with caution. The antenna was designed to work reliably and flawlessly for years without special maintenance.



Attention! The surfaces should be cleaned with a clean, soft cloth dampened in a dishwashing liquid – water solution. The use of alcohol, spirit, thinners, glass cleaners or other harsh cleaning liquids is prohibited and will damage the acrylic plate.

To improve the durability and the appearance, please follow the instructions below:

- Keep the antenna clean and take care the antenna is not scratched. Also regularly apply specific antistatic products for acrylic surfaces.
- Regularly remove dust and other impurities with a soft cloth and a solution of water with a little dishwashing liquid.
- Keep the antenna dry. All kinds of moisture should be avoided during operation and storage. Precipitation, humidity and liquids contain minerals that will corrode electronic circuits and damaging transparent plastic parts.
- Protect the antenna from high temperatures. Mount the antenna away from heaters and other heat sources. Operation under direct sunlight can cause extreme high temperatures and a fading cause of the surface.
- Avoid storing or operating the antenna at dirty or wet locations. The surfaces or electronic components may be-damaging.
- Handle the device with care. Shocks may break internal circuit boards.
- Do not try to open the antenna during operation or outside maintenance periods. Non-professional management can result in damage to the device.

If any device not working properly, please contact the appropriate representative.

4 Performance Features

4.1 Scope of delivery

4.1.1 Antenna ID ISC.ANT1710/690-A Crystal Gate Type A

- Antenna ID ISC.ANT1710/690 inclusive dynamic antenna tuner
- Long Range Reader Module ID ISC.LRM2500-B
- 4 times Multiplexer Module ID ISC.ANT.MUX.M4
- Wide range power supply ID ISC.NET24V-B 100-240V/ 24V (without power cable with IEC plug)
- People Counter ID ISC.ANT.GPC
- Alarm LED / Sounder
- Mounting Instruction

4.1.2 Antenna ID ISC.ANT1710/690-B Crystal Gate Type B

- Antenna ID ISC.ANT1710/690 inclusive dynamic antenna tuner
- Alarm LED
- Data cable 2,5m long, LED/People Counter
- Antenna connector cable, about 8m long

4.2 Performance Features of the ID ISC.ANT1710/690 Crystal Gate Antennas

The ID ISC.ANT1710/690-A Crystal Gate Type A antenna is a version with integrated dynamic Antenna Tuning Board ID ISC.DAT , Long Range Reader ID ISC.LRM2500-B, 4-times Multiplexer Module ID ISC.ANT.MUX M4, additional Alarm LED light, Alarm sounder and People Counter GPC.

Additionally, one People Counter board and one radar sensor are already integrated in the antenna

The ID ISC.ANT1710/690-B Crystal Gate Type B antenna is a version with integrated dynamic Antenna Tuning Board ID ISC.DAT and Alarm LED light mounted, only.

Up to

- two antennas with reader and multiplexer as a single gate,
- three to four antennas with reader and multiplexer as a double gate or triple gate
- up to 7 antennas as multiple gate with up to 6 aisle at the use of the 8-times Multiplexer ID ISC.ANT-MUX M8.(not included)

can be operated.

Depending on the antenna configuration, one, two or all three read orientations of the Smart Tags and various aisle widths (gate widths) are possible.

The People Counter, integrated in antenna type A, can be easily extended to two passages with the help of the option ID ISC.ANT.GPC-E2 extension Radar Detector.

The ID ISC.ANT1710/690-A/B Crystal Gate is a „figure-of-eight“ antenna with tuner and has been optimized as transmitting and receiving antennas for the ID ISC.LRM2500 Reader. It is however also possible to operate them with other readers at a transmission frequency of 13.56 MHz and an output impedance of 50 Ω. The read ranges indicated in this document and the tuning procedures may vary.

The antennas comprise the electrical antenna conductor, the housing, the ID ISC.DAT Dynamic *Antenna Tuner* and the connection cables. The antennas are tuned to the factory default to an impedance of 50 Ω in a magnetically neutral environment at a distance of 95 cm. When installing in different ambient conditions the antenna can be retuned using the “DATuningTool“ PC software.

After tuning, the antennas will retain their settings as long as the ambient conditions remain unchanged.

The antennas can be used for detecting both product and persons. It is for indoors use, only.

Performance Features of the ID ISC.ANT1710/690 Crystal Gate Antennas

4.3 Performance Features of the People Counter (ID ISC.ANT.GPC)

The product ID ISC.ANT.GPC, short form “Gate People Counter” or “GPC”, are made for mounting in the antennas ID ISC.ANT1710/690 Crystal Gate.

A Gate People Counter consist of a People Counter board (PC) and one Radar Detector! The product ID ISC.ANT.GPC-E2 Extension Radar Detector is used to extend the People Counter to a second gate aisles.

The People Counter has two counters per aisle. The values of the incoming and outgoing persons will be separately captured.

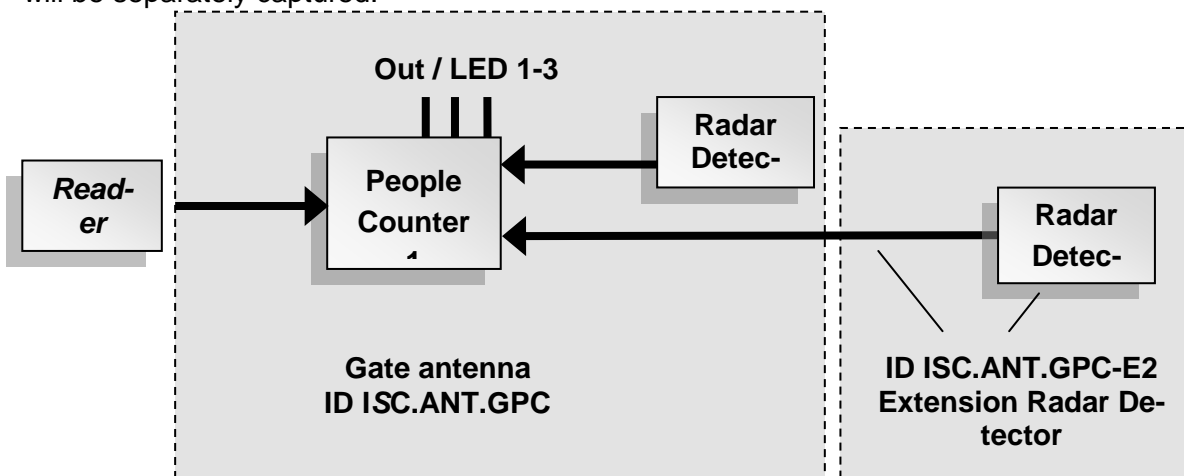

Fig. 1: Gate People Counter Structure (2-3 antennas, 1-2 gate aisles)

A change of the counter values will be stored in the EEPROM of the People Counter board. By sending the command “0x78 Set People Counter” the values could be set/reset to the needed value.

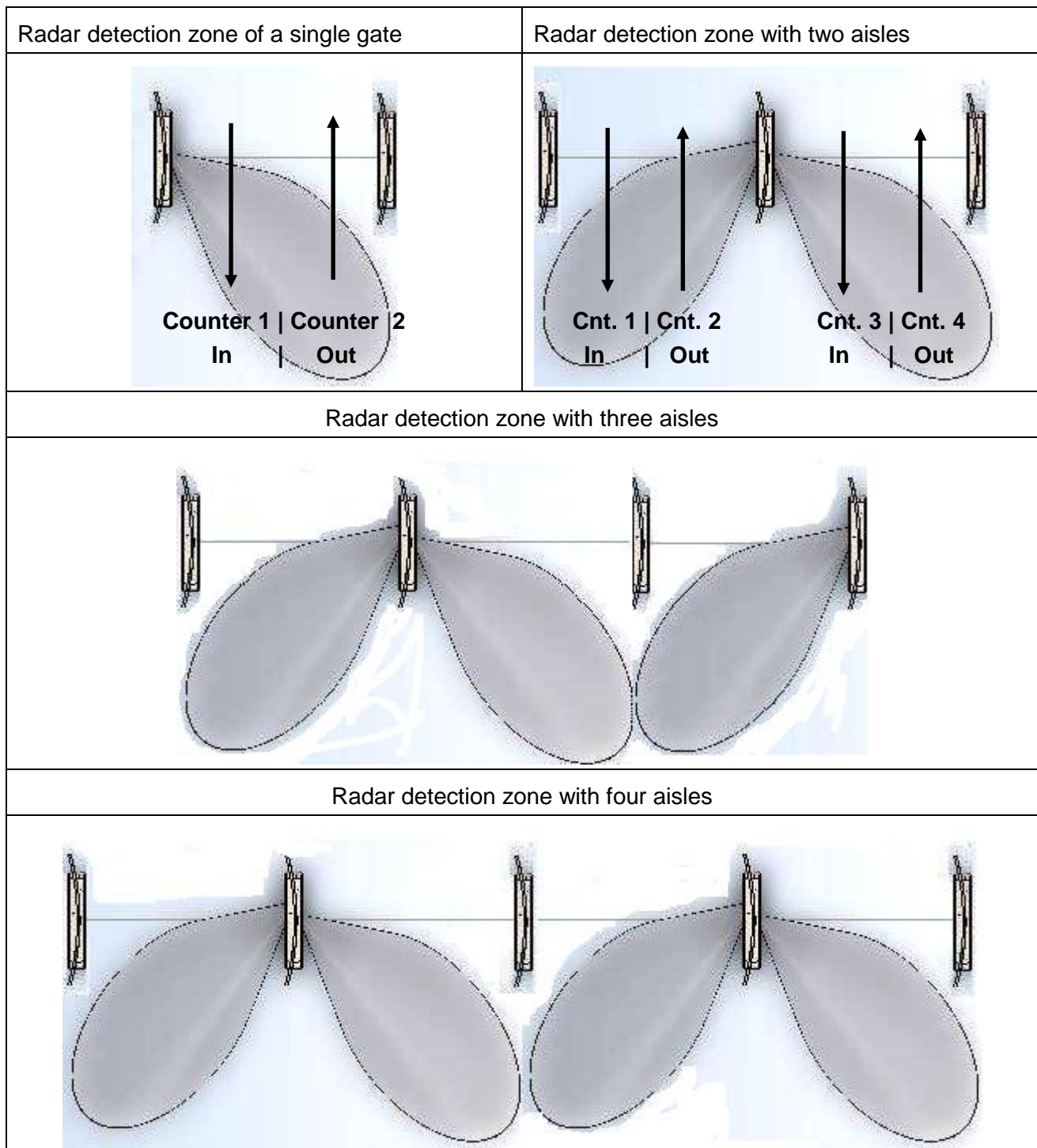

Fig. 2: Top view of the detection areas (2-5 antennas, 1-4 gate aisles)

The People Counter board and the Radar detectors are mounted in the base of the antennas. Due to the radar beam can pervade the plastic housing of the antenna, no openings a necessary.

The three digital output can be used, to enable a alarm light at every gate antenna or activate an alarm sounder in the gate antenna.

The Connection between reader and people counter takes place through the RS485 Interface of the reader, inside the antenna.

There is no need of a direct connection from the GPC to the Host. All commands from the Host to the People Counters are embedded in the Pickyback command of the reader.

Generally, there are two possibilities to get the actual people counter values. Either the Host poll the People Counter periodically or in the Notification Mode of the reader, the reader send a notification protocol at every change.

In ISO Host or Buffered Read Mode, the host poll the GPC by sending protocols. Only, in the Notification Mode, the reader poll the counter values, automatically, and send data according the reader configuration to the host.

See also System Manual H01011-xe-ID-B.DOC

4.4 Available Antenna Types

The following products are currently available:

Antenna Type	Description
ID ISC.ANT1710/690-A Crystal Gate Order No. 4850.000.00	Antenna with Reader, Multiplexer , Dynamic tuning board DAT, Alarm LED light, Alarm Sounder, People counter GPC and 24 VDC power supply.
ID ISC.ANT1710/690-B Crystal Gate Order No. 4851.000.00	Antenna with Dynamic tuning board ID ISC.DAT and Alarm LED light
ID ISC.ANT.GPC Gate People Counter Order No. 4704.000.00	People Counter and one piece of radar detector for antenna ID ISC.ANT1710/690 incl. Mounting and cabling set. (optional)
ID ISC.ANT.GPC-E2 Extension Radar Detector Order No. 4718.000.00	Second radar detector with cable for the second direct parallel aisle (optional)
ID ISC.ANT.CRG-MP Crystal Gate Mounting plate Order No. 4412.000.00	Metal mounting plate for soft ground and drilling template.

Table 1: Available Antenna Types and Accessories

Required components to setup a gate by using the Gate People Counter:

Number of antennas	Antenna		People Counter (Optional)		Note
	ID ISC. ANT 1710/690 -A	ID ISC. ANT 1710/690 -B	ID ISC. ANT.GPC	ID ISC.ANT. GPC-E2	
2 Antennas	1	1	0		1 piece GPC included in antenna type A
3 Antennas	1	2	0	1	1 piece GPC included in antenna type A
4 Antennas	1	3	1	1	1 piece GPC included in antenna type A
5 Antennas	1	4	1	2	Change to 8 Chanel Multiplexer, 1 piece GPC included in antenna type A
6 Antennas	1	5	2	2	Change to 8 Chanel Multiplexer, 1 piece GPC included in antenna type A
7 Antennas	1	6	2	3	Change to 8 Chanel Multiplexer, 1 piece GPC included in antenna type A

Table 2 Required components for gates with People Counter

5 Installation and Wiring

Notes:

Before installing the antennas please read [6.1 Project Notes Antenna](#). The spacing of the antennas in a gate depends on the antenna configuration.

If multiple antennas or gates are connected to different readers, a minimum clearance of 8 m must be kept between the antennas or gates. For shorter distances (1 m – 8 m) the readers must be synchronized. The synchronization of the readers "☞" (see application note N10311-xe-ID-B.doc) is only possible in one of the Automatic Modes (Buffered Read, Notification or Scan Mode). Below a distance of 1.5 m the antennas must also be shielded from each other. Otherwise the read range will be significantly reduced. The antennas must have a minimum distance of 20 cm to all larger metal parts! At a distance of less than 50 cm between the antenna and metal parts the read range will be significantly reduced.

5.1 Mounting Preparation

For the assembly of the antenna it has to be carefully unpacked and the antenna base to be opened. This is done as described in the following steps:

1. Place the packed antenna on the floor with the top side facing up. Carefully open the box and then remove the antenna.



Fig. 3: Packed Antenna

2. Afterwards, the antenna has to be placed carefully on the floor again. Now, the two fastening screws (hexagon socket width AF 2,5) have to remove of the antenna base cover. By moving the cover upwards, carefully, remove the cover from the antenna base. Fig. 4

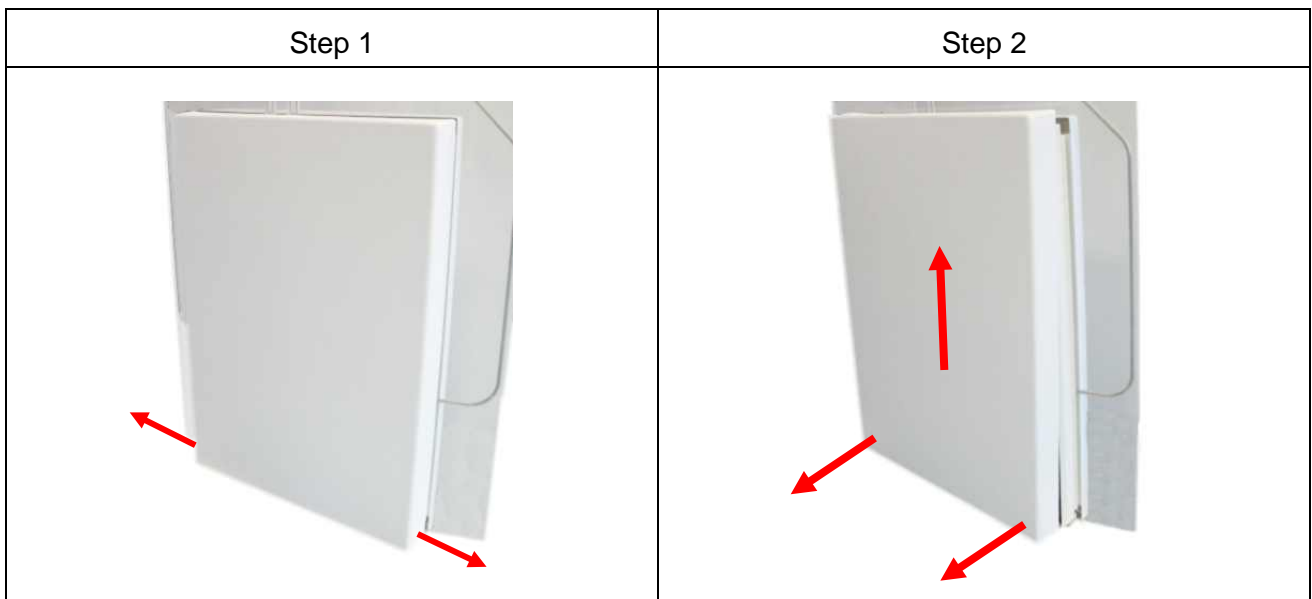

Fig. 4: Opening the antenna base

5.2 Installing the antenna

5.2.1 Dimensions of antenna

The overall dimensions of the antenna are shown in Fig. 5

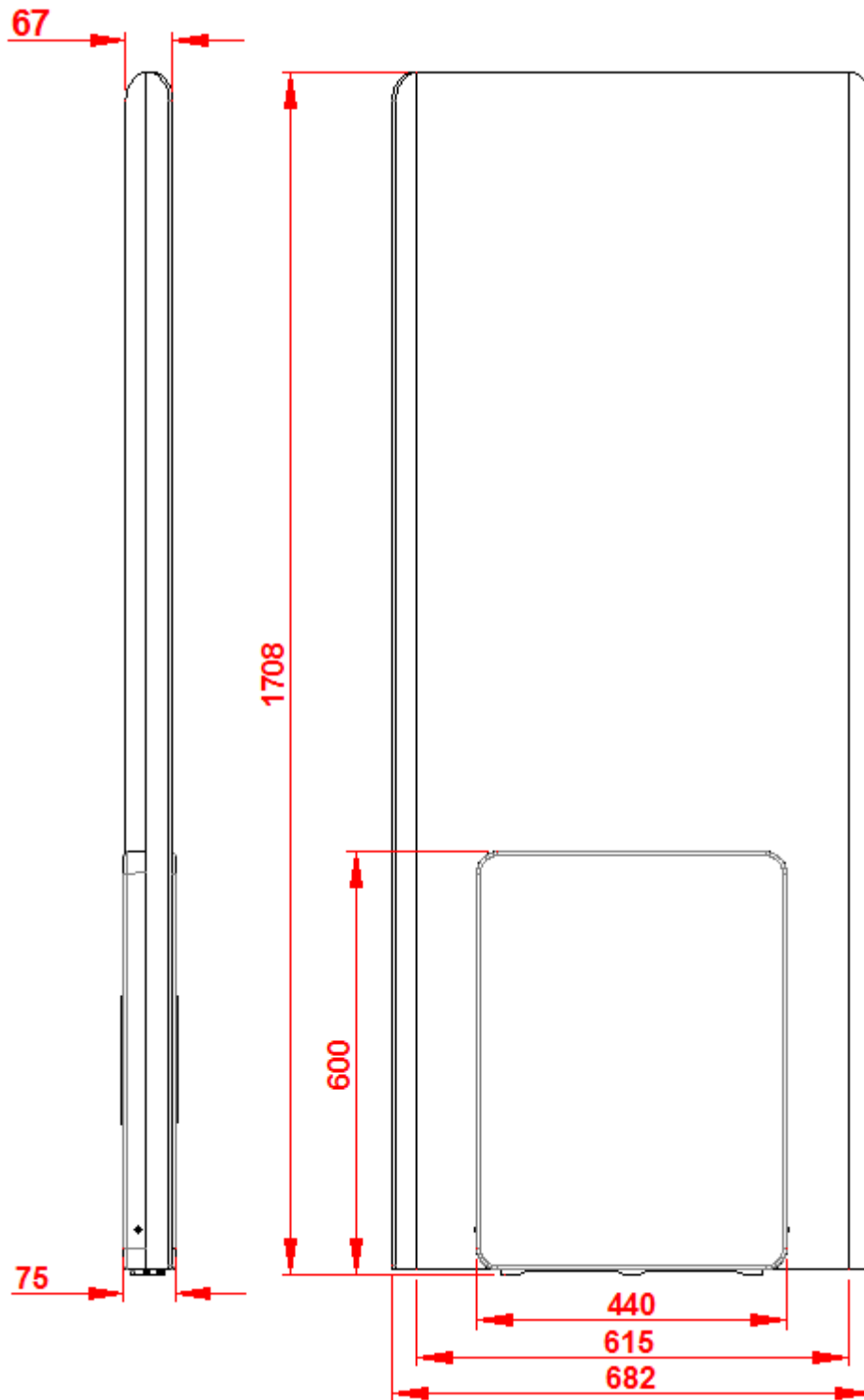

Fig. 5: Antenna outside dimensions

All dimensions are in mm with general tolerance according to ISO 2768 m (mean).

5.2.2 Drilling the Mounting Holes

If the position of the antennas has been marked or determined, the mounting holes and the holes for the cable entry, can be marked and drilled. To make this easier the ID ISC.ANT.CRG-DT Crystal Gate Drilling Template could be used.(optional). This Drilling template could also be used for stabilization and weight distribution on soft grounds by mounting it additionally under the antenna foot. The dimensions are shown in Fig. 6:

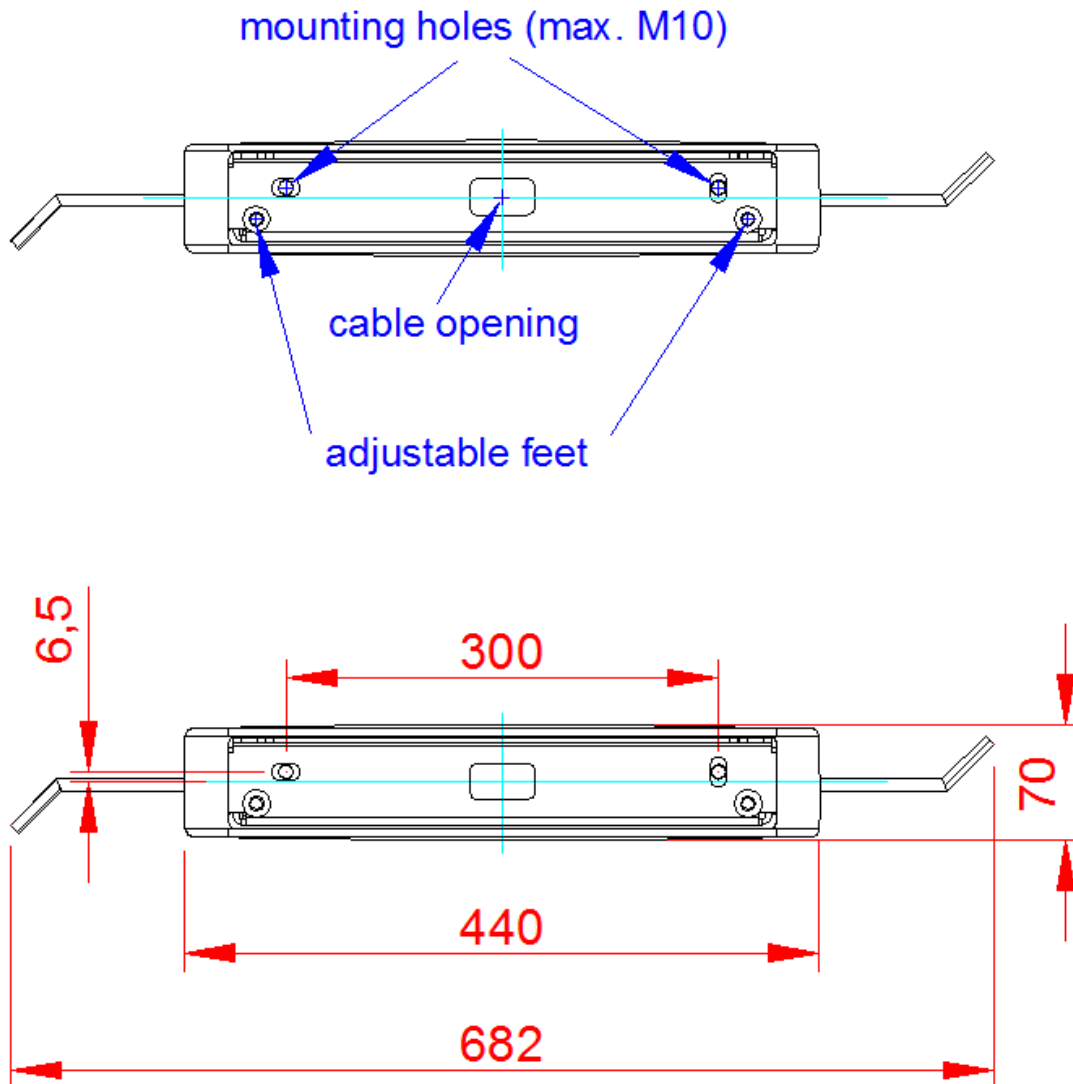

Fig. 6: Floor plate dimensions

All dimensions are in mm with general tolerance to ISO 2768 m (middle).

The size and type of the anchors depends considerably on the strength of the base or floor. The anchors should be capable of withstanding a permissible load of at least 5 kN per anchor for all load directions (e.g. for concrete floor Hilti HVA anchors with HAS-(E) M8 threaded rod or Hilti HIS-N M8 (5/16") threaded inserts). The size of the mounting holes in the antenna is 10 mm (.39"). The length of the anchors or bolts should be selected such so they just look out at least 40 mm (1.6") and maximum of 55 mm (2.2") of the floor.

Please follow the mounting instructions of the anchor manufacturer!

A cable opening is provided for the necessary connection cable (see Fig. 6). The cable opening is dimensioned such as up to 10 cables having a diameter of 6 mm can be passed through the opening.

Alternatively the cables can be routed at the sides of the antenna bas like shown in Fig. 7

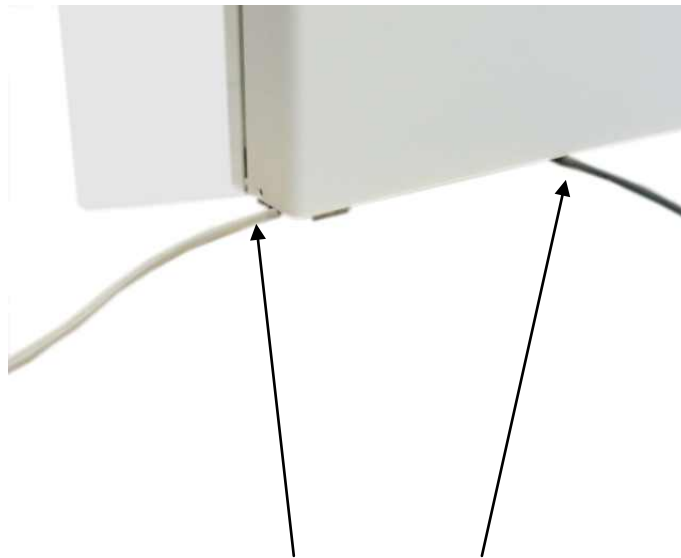

Fig. 7 Cable routing at the antenna sides

5.2.3 Installing the Antenna Base and Antenna Body

The antenna will be mounted on the floor. Please note, the antenna conductors in the middle of the antenna body have to have the same direction (Fig. 8). If a People Counter is installed in the antenna, then note chapter [6.2 Project Notes People Counter \(GPC\)](#). Afterwards, the antenna has to be aligned vertically, by using the adjusting screws (Fig. 9).

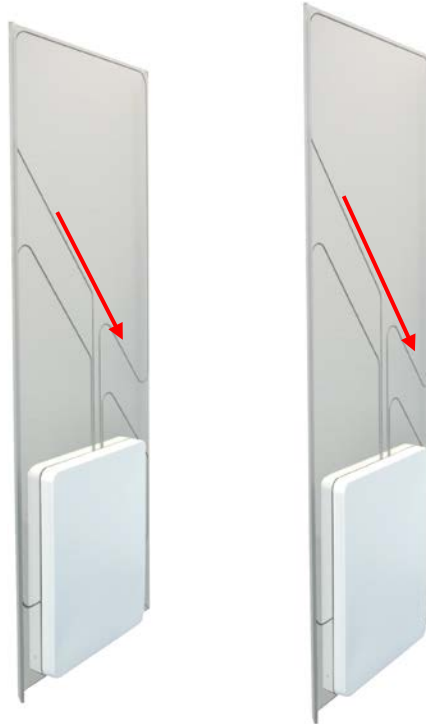
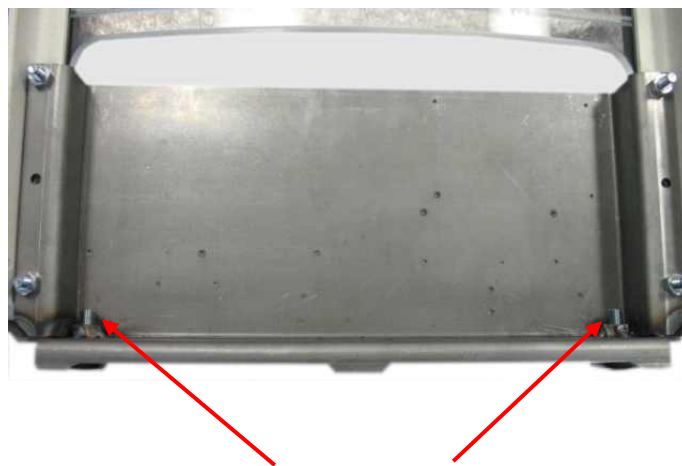

Fig. 8 Conductors shape have to have same direction



Adjusting screws (hexagon socket width AF 4)

Fig. 9: Attaching and aligning the antenna

6 Typical Antenna Configuration (Gate Antenna with two Antennas)

The standard configuration of a gate with three-dimensional tag orientation consists of one ID ISC.ANT1710/690-A Crystal Gate with reader and multiplexer and one ID ISC.ANT1710/690-B Crystal Gate. If a tag moves, at horizontal line, through the gate, it can be read at least once. This ensures high reliability of the antenna system.

6.1 Project Notes Antenna

The antenna configuration as described allows detection of a tag moving at a horizontal line, through the reading area of the gate. The tag orientation is non-critical. The tags are detected along a horizontal axis of motion in certain regions within the antennas. The area of detection depends on the tag orientation.

The size of the three-dimensional reading area of the antennas is shown in the sketch below.

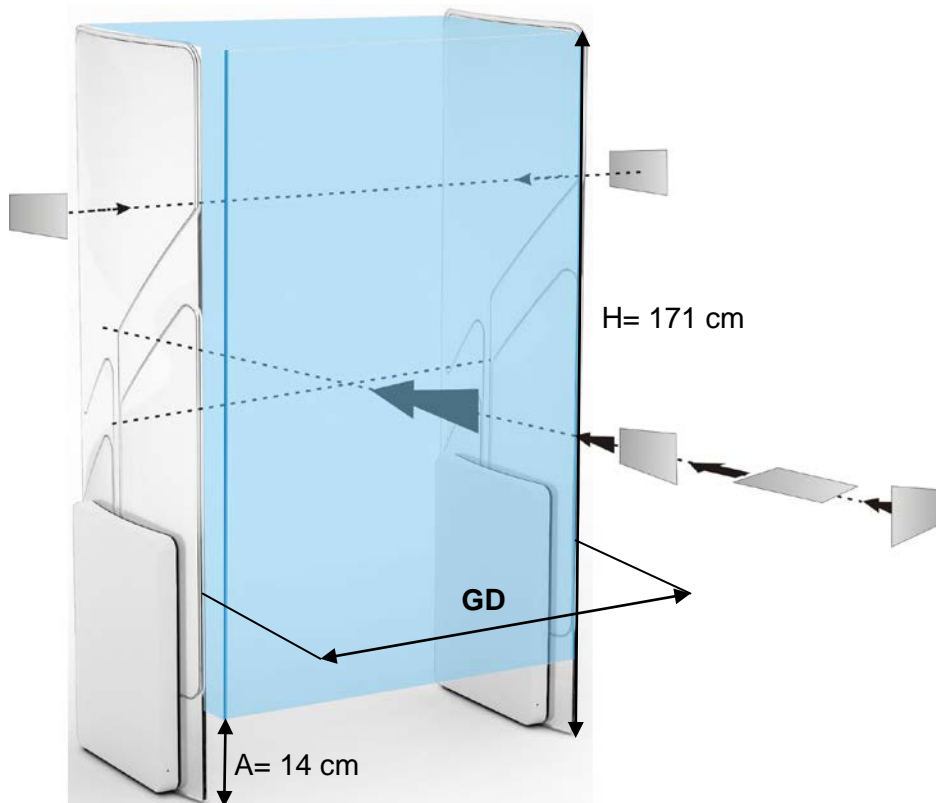

Fig. 10: Capture area and tag orientation

Notes:

Note that the entire reading area of the antenna gate is larger than the three-dimensional area shown in the drawing (Fig. 11). This means there are tag orientations in which the tag can be detected outside the reading area.

To get a optimal performance the reader has to be configured and run in one of the Automatic Modes (Buffered Read, Notification or Scan Mode).

If multiple gates are arranged with short distances (1-8m) between each other, these will mutually interfere with each other. In this case, the readers for the individual gates have to be synchronized and run in one of the automatic modes.

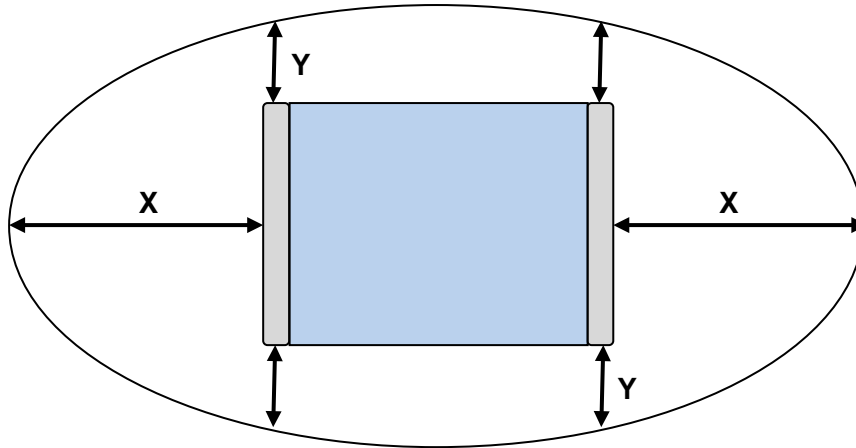

Fig. 11: Top view, capture area outside of the antenna gate

Direction	Minimum Distance
right, left (X=)	70 cm
front, behind (Y=)	30 cm

Table 3: Capture area, unintentional detection

To achieve three-dimensional reading of the tag in the reading area drawn above ([Fig. 10](#)), the following conditions must be fulfilled:

- The gate distance (GD) depends on the antenna configuration (see Table 5:).
- The tags should be at least ISO card size (46 mm x 75 mm).
- The activation field strength of the tags should be less than or equal to 60 mA/m.
- The distance from tag to tag should be greater than 10 cm. If the tag to tag distance is reduced, the gate distance GD must be reduced correspondingly. This applies in particular to distances under 5 cm.
- The maximum number of tags (serial number or data) depends on the traverse speed with which the tags are brought through the capture area of the gate (see Table 5:). The number of tags may be increased in the gate distance GD is correspondingly reduced and the maximum speed adjusted accordingly.
- The antenna should be at least 50 cm away from metal parts.
- The minimum distance between the antennas of a gate and other antennas of RFID work station or terminals (transmitting frequency 13,56 MHz) should be:

Transmitted output power	Minimum Distance
< 0.5 W	1 m
0.5 W-1.0 W	2 m
1.1 W – 2.0 W	3 m
> 2 W	4 m
>= 4 W	8 m

Table 4: Minimum Distances

- There should be no interference of the Reader from other electrical devices in the environment. The Noise Level difference should be less than 20 mV.
- The ID ISC.LRM2500 reader should be set to an RF power of 8 watts.
- When using ISO 15693 transponders, the Readers should be set as described in [6.4.6 Reader Configuration](#).
- If multiple gates are operated at the same time at a distance of less than 8 m, the Readers must be synchronized. See Application Note *Synchronizing RFID Long Range Readers using the digital in-/outputs* (N10311-xe-ID-B.pdf).

	Gate with antenna Type A and Type B
Gate distance GD	≤ 95 cm
Number of tags at a speed of 1 m/s	
- Read serial number	16
- Read data	8

Table 5: Gate distance

Supplementary equipment (e.g. light barrier, lighting, etc.), mounted directly on the antenna or in the immediate vicinity of the antenna can interfere with the functioning of the system.

A minimum distance of 20 cm is required.

Electrical cable, directly at the antenna or in the immediate vicinity of the antenna, can be cause interference. A minimum distance of 20 cm is required.

A minimum distance of 65cm between the two gate antennas is required.

6.2 Project Notes People Counter (GPC)

The radar sensor of the People Counter detect moving objects within the detection area / beam (A1, A2, see Fig. 12) of the radar antenna. The size of the detection area, and hence the sensitivity of the devices can be adjusted with the ISO-Start Software. [7.2.2 Configuration and Test in ISO-Host or Buffered Read Mode](#)

A door (including glass doors), a curtain and in particular automatic doors or other moving objects can influence the counting of the People Counter much.

If a People Counter is installed in the antenna, the antenna conductors in the middle of the antenna body must be aligned, that the red arrows show, according to [Fig. 8 \(Conductors shape have to have same direction\)](#) in the direction of free space.

That means, the antennas are installed close to the entrance and exit, the detection area of the radar sensors must show away from the door. Otherwise, a minimum distance of 1.0 m between moving objects and detection areas must be guaranteed.

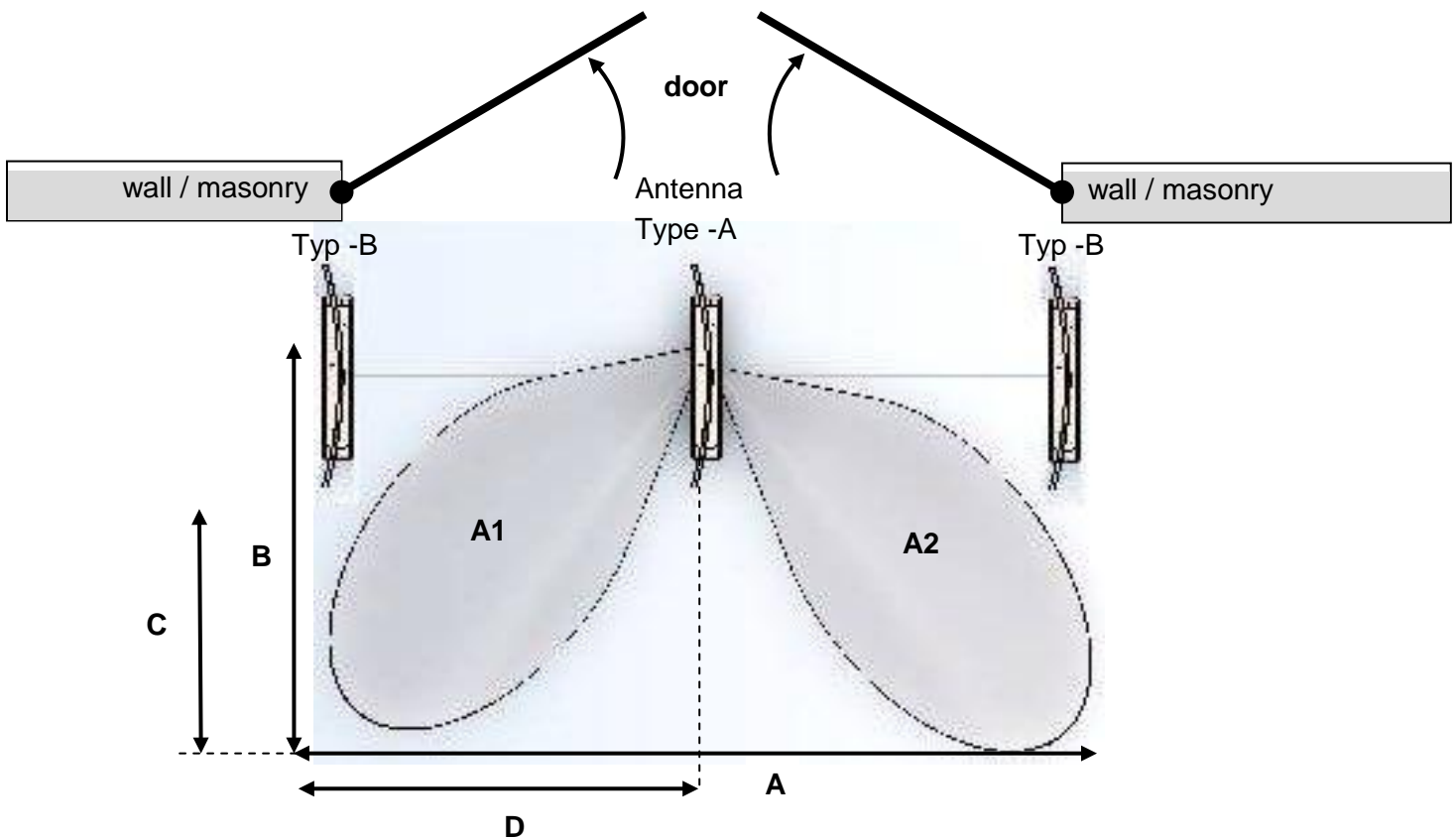

Fig. 12: Top: Detection area A1 und A2 (Foot print) of the radar sensor

Sensitivity	Low	Medium	** <u>High</u>	Very high
Distance A	180 cm	200 cm	200 – 220 cm	240 - 260 cm
Distance B	60–70 cm	80-90 cm	100-110 cm	120 – 130 cm
Distance C	20-30 cm	40-50 cm	60-70 cm	80-90 cm
Distance D	90 cm	100 cm	100 – 110 cm	120 - 130 cm

Table 6: Detection area radar sensor, antenna distance 1m

** Standard configuration

All values are approximate, depending on the size of the objects, the behavioral reflection of the floor and the material of the moving object.

If two people (or moving objects) move, simultaneously, in the detection area of one radar sensor, usually, is counted one person, only.

The minimum distance between two people, so that these people are detected separately, as a function of the adjusted sensitivity and position in the passage is 60 cm to 130 cm.

Cross traffic in the detection area, i.e. people who cross in front of the antennas, go from left to right (or contrariwise), can also be counted or recorded.

To avoid interference, the detection area of radar motion detector, mounted above or at automatic doors (Operating frequency 24.125 GHz), must not overlap with the detection area People Counter.

The People Counter was designed to obtain statistical values on visitor flows. By people with small distances, due to interferences, and by cross traffic, can vary the determined values of the actual values.

If greater deviations are found, at first, the sensitivity of the radar sensors should be reduced stepwise.

6.3 Project Notes People Counter Direction Detection Mode

In combination with the People Counter a direction detection of the transponders could be performed in that way, that only transponder will cause an alarm which move in the configured direction through the gate. If people with transponder go in no alarm occur. Also at people how pass the gate transverse or pass outside gate setup now alarm should occur. This reduce false alarms.

According the reader configuration, only alarm LED1 and/or LED2 are triggered.

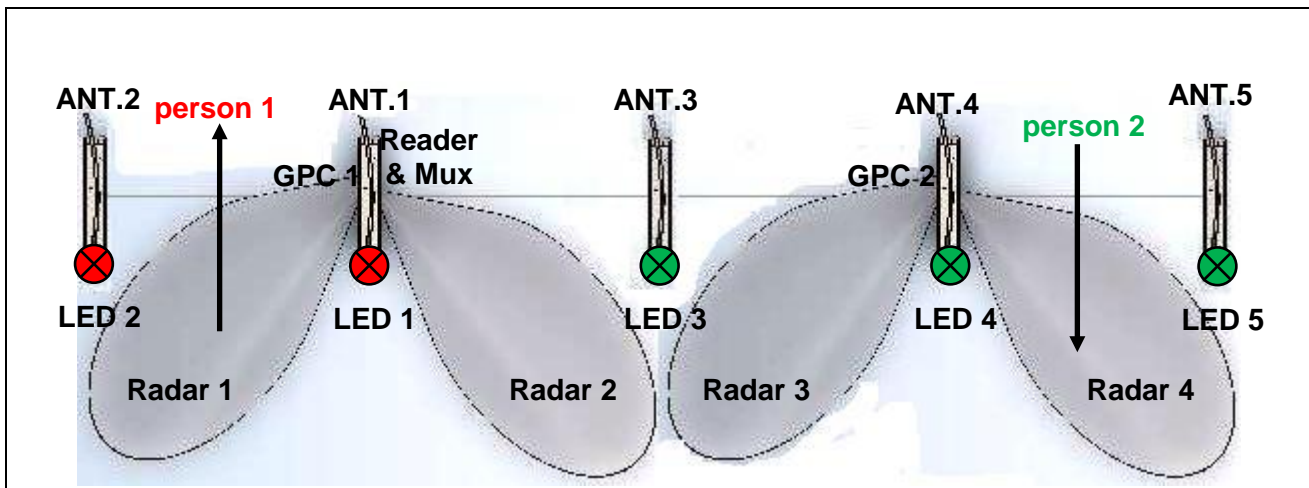

Fig. 13: Top: Set up with 4 aisle. At aisle 1, person 1 activate a alarm

6.4 Gate Configuration and Setup using Antennas

6.4.1 Required Components

To set up the gate you need the following components:

- Qty. 1 ID ISC.ANT1710/690-A Crystal Gate (Base)
(incl. Qty. 1 ID ISC.NET24V-B Power Supply Unit)
- Qty. 1 ID ISC. ANT1710/690-B Crystal Gate
- Power cable, interface cable and connection cable for the DC power supplies (2-wire, twisted)
- Mounting materials (screws, anchors)

To calibrate the Reader you will need the software

- ISOStart 2017 Version 09.09.14 or higher

on a personal computer running under Microsoft® Windows®. The service can be downloaded at the Download Area of the Homepage www.feig.de.

6.4.2 Configuration of a Gate Antenna with Multiplexer

Connect the components as shown in Fig. 14. Almost, all cable should be mounted already. Normally, the antenna cable from antenna Type B has to be connected to OUT2 at the multiplexer and the 24V DC power supply to X11 of the terminal board only. Also a connection between X13 GPC-out of the terminal board in Antenna Type A and X13 GPC-out of the terminal board in Antenna Type B must be installed to supply the LED with power and RS485 Bus.

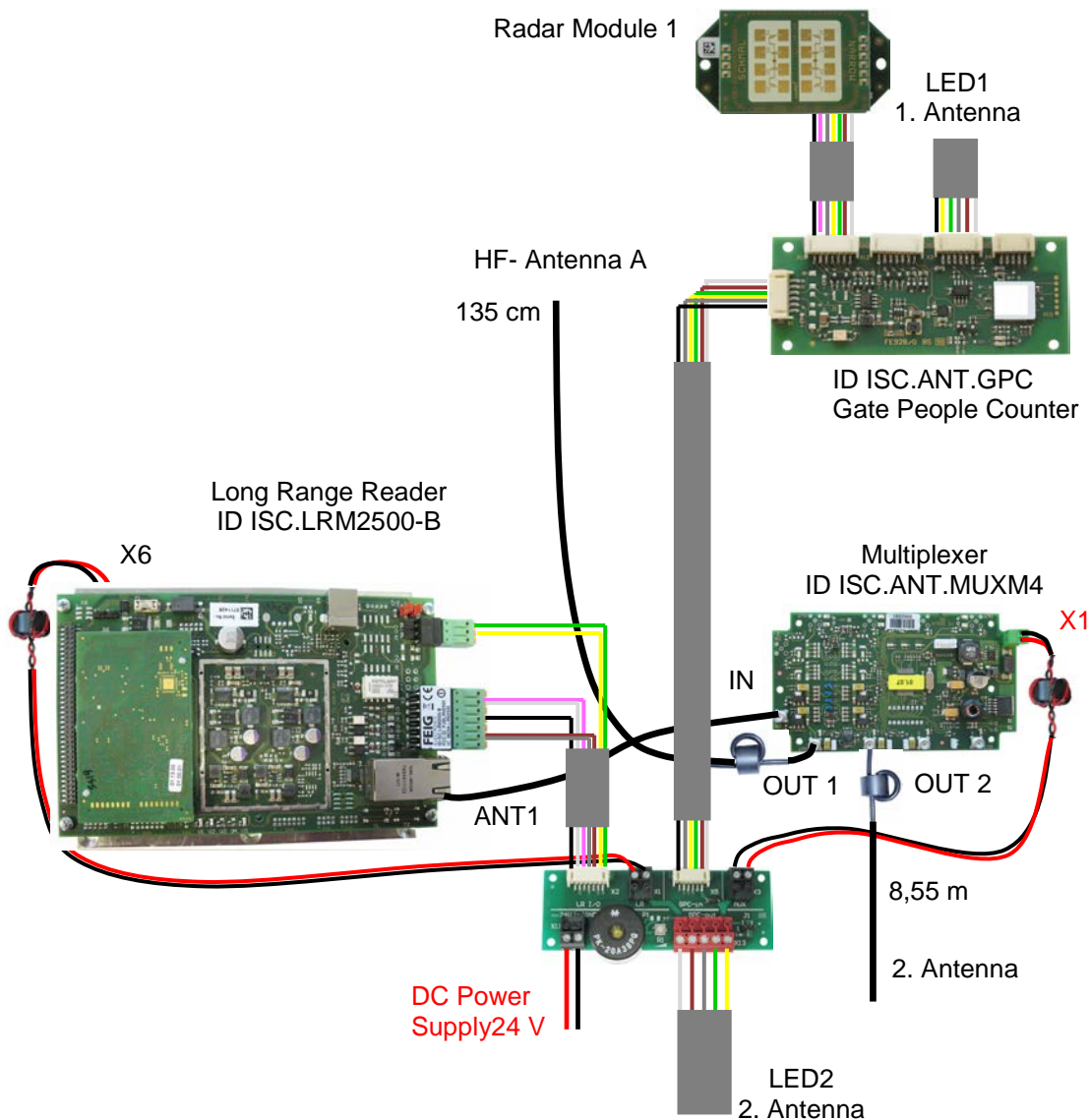

Fig. 14: Connecting the components for a gate consisting of two antennas, reader and multiplexer

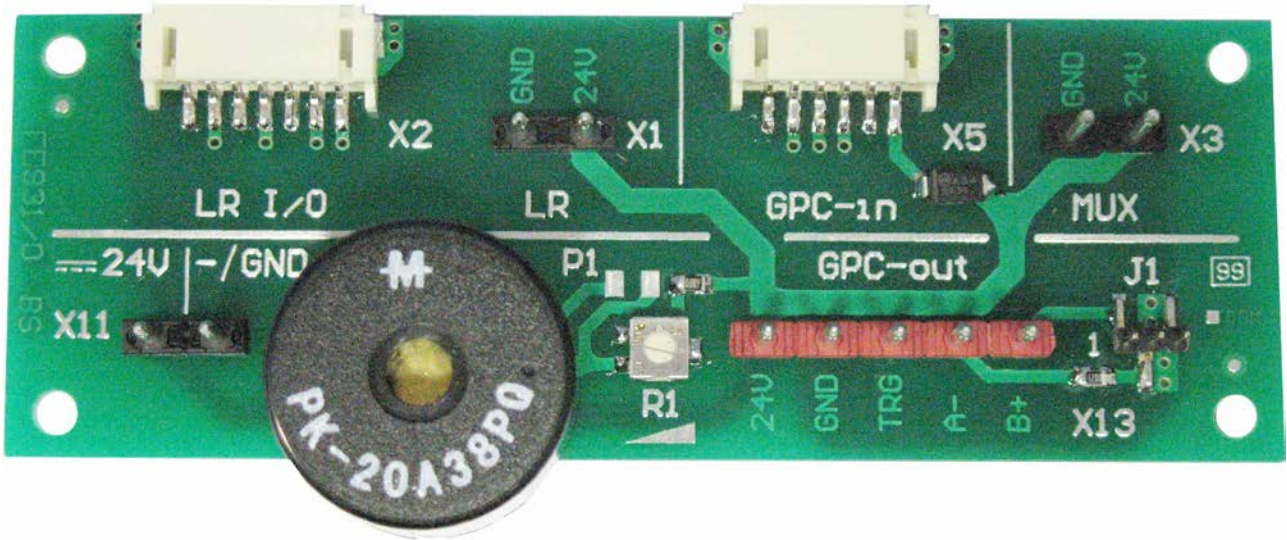

Fig. 15: Terminal board

An overview of the terminal board assignment is given in [10. Annex A](#)

Note:

- **A reverse polarity could damage the device or the In-/Outputs.**

The connection between Antenna Type A and Type B must be made with the data cable which is content of the Antenna Type B. The ferrite core should have 3 turns of the cable approx. 7cm at the cable end.



Fig. 16: Connection cable

The connection of the LED Antenna Type B with the Terminal Board in Antenna Type A must be made as following. . For the connection you have to use a 2 (4) pin shielded, twisted-pair cable. Example: LiYCY (TP) 3x2x0,25 . The connection cable (length 2.5m) is included in antenna type B!

Find here the wire connection between antenna Type A and B
 At a single gate with 2 antennas a connection between X13 GPC-out of the terminal board in Antenna Type A and X13 GPC-out of the terminal board in Antenna Type B must be installed.
 The side with the ferrite core must be placed in the antenna Type B.

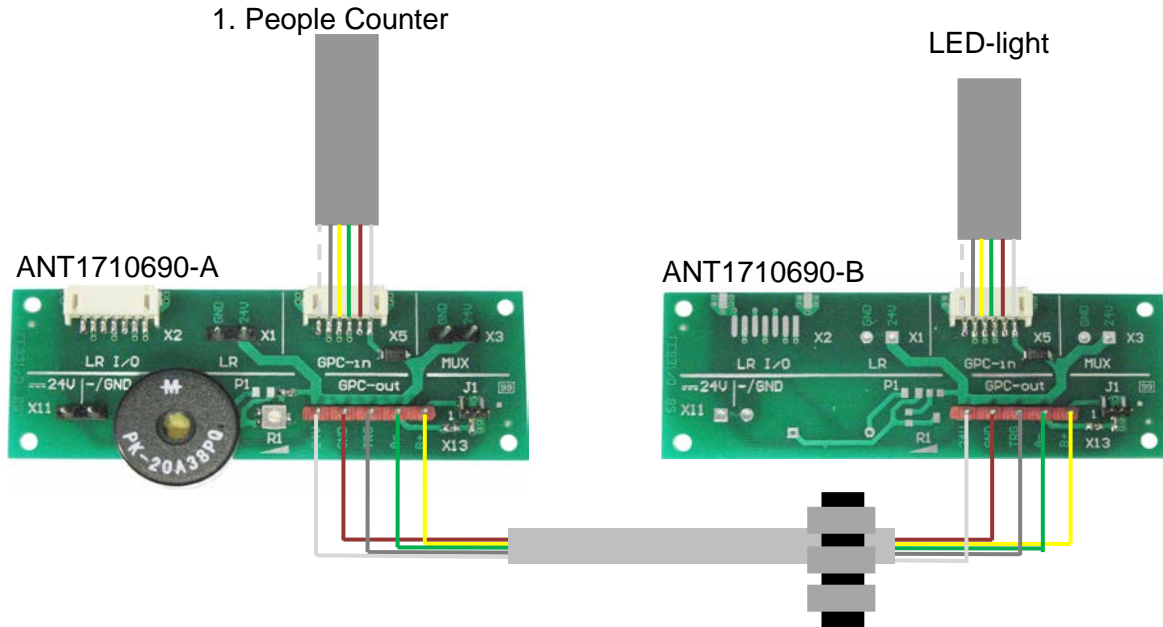

Fig. 17:Connections of the LED-light, between antenna Type A and Type B

At a double gate with 3 antennas a connection between
 X13 GPC-out of the terminal board in Antenna Type A and X13 GPC-out at the 1. Antenna Type B
 and X13 GPC-out of the terminal board in Antenna Type A und X13 GPC-out at the 2. Antenna
 Type B must be installed. The sides with the ferrite core must be placed in the antenna Type B.

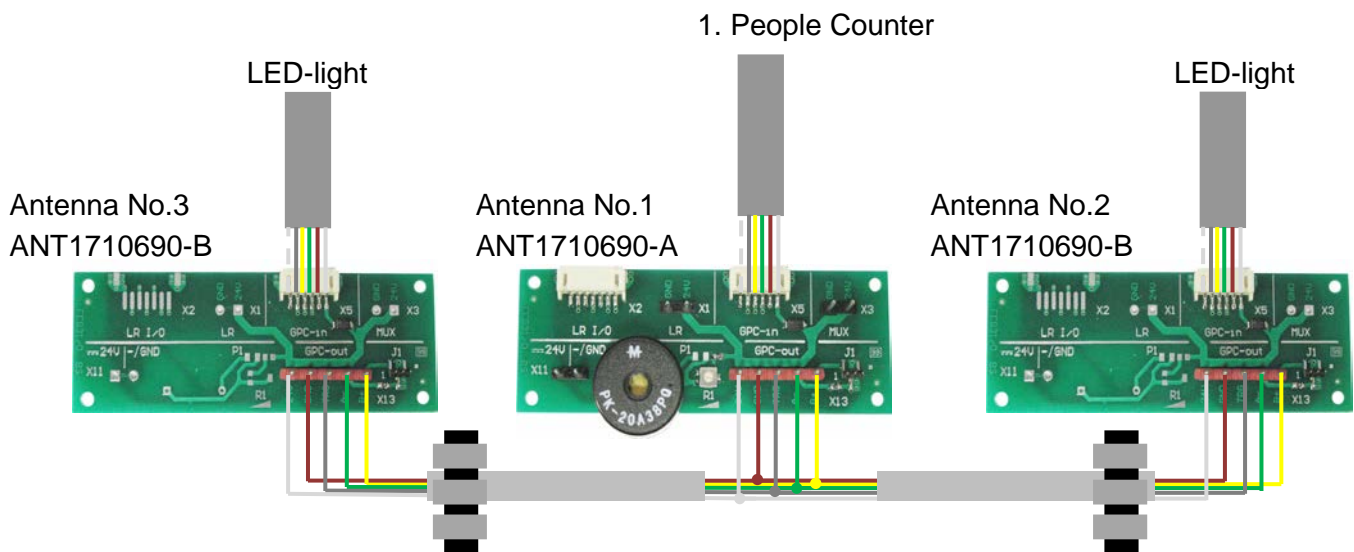

Fig. 18:Connections of the LED-lights, between three antennas Type A and Type B

Basically X13 GPC-out of the terminal boards of all used antennas must be connected from antenna to antenna 1:1 in parallel.

The coax cables have fixed lengths and may not be shortened and therefore need to be tied into small loops (see Fig. 19). Tie all cables as far away from the antenna conductor as possible. The cables must never be allowed to contact the antenna conductor. Unused cable length (e.g. of interface cable) should not be placed in the area above the reader and multiplexer. The power supply should not be placed in the type A antenna.



Fig. 19: Connection of the components in an antenna Type A

The cable from antenna type B to the antenna type A should preferably be connected shortly. Unused cable lengths are possible should be tied in antenna B type. Tie all cables as far away from the antenna conductor as possible. The cables must never be allowed to contact the antenna conductor. It is possible to place the power supply in foot of the antenna type B. The ferrite core must be installed after installing the cable 10cm at the cable end of the cable in antenna type A with 3 turns.



Fig. 20: Unused coaxial cables are tied in antenna Type B

6.4.3 Setting the Multiplexer

The jumpers JP11-JP14 should be set (factory setting) as shown. More on setting the ID ISC.ANT.MUX.M4 Multiplexer can be found in the corresponding installation manual (M90700-xde-ID-B).

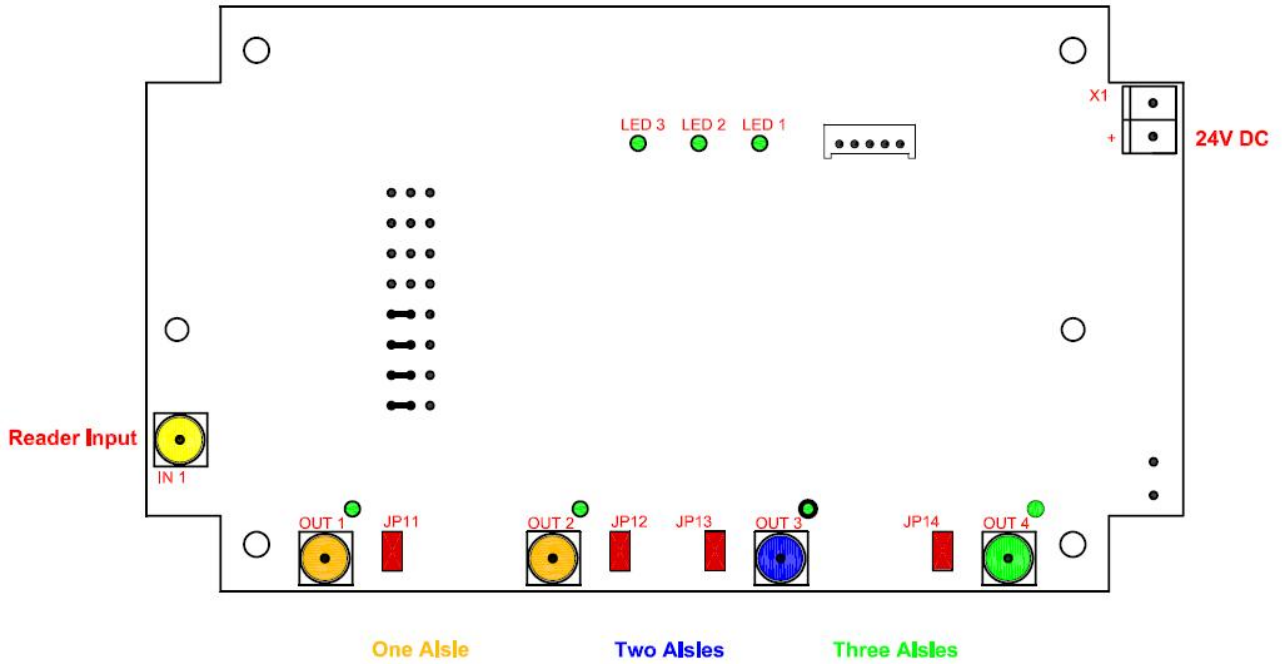

Fig. 21: Jumper positions

6.4.4 Setting the Antenna Tuner

For checking the settings of the antenna tuner the antenna base has to be opened. For this the two fastening screws (hexagon socket width AF 2,5) have to remove of the antenna base cover. By moving the cover upwards, carefully, remove the cover from the antenna base.

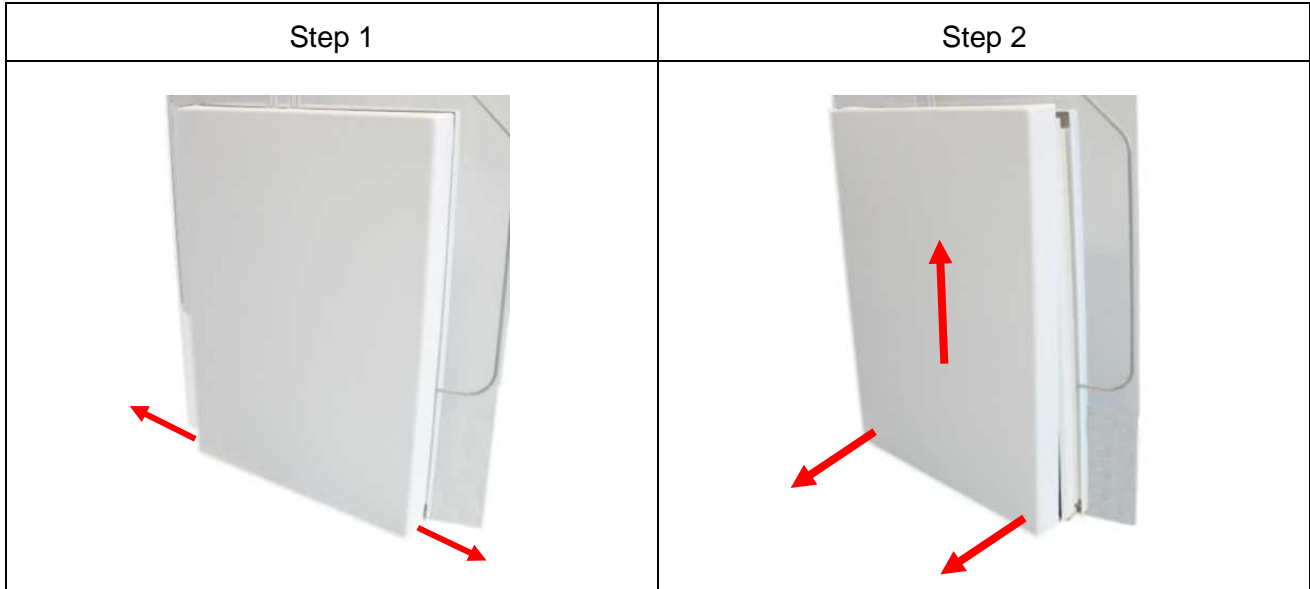
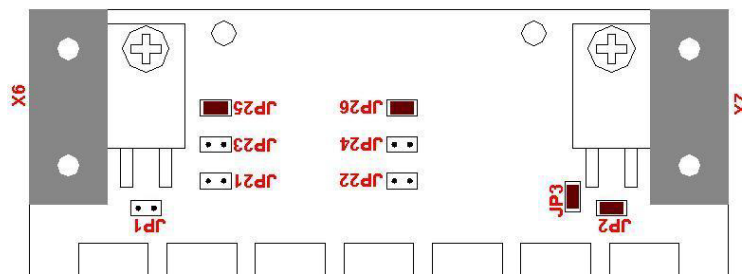

Fig. 22 Removing the antenna base covers

The jumpers JP1-JP26 of the Dynamic Antenna Tuning board should be set (factory setting) as follows:

Table 7: Jumper settings for Antenna Tuner

Function	Jumper	Position
1Ω Q resistor	JP1	open
2Ω Q resistor	JP2	closed
Antenna switch	JP3	closed
Capacitor C1	JP 11,12,13,14	open
Capacitor C2	JP 21,22,23,24 JP 25,26	Open closed



Verify these settings. More on setting the ID ISC.DAT antenna tuner can be found in the corresponding installation manual (M40401-xde-ID-B).

6.4.5 Interface Connections

6.4.5.1 LAN / TCP/IP

The Reader has an integrated 10 / 100 Base-T network port for an RJ-45. Connection is made on X1 and has an automatic "Crossover Detection" according to the 1000 Base-T Standard.

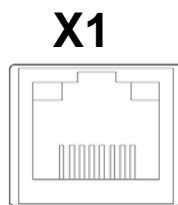

Fig. 23: LAN interface for host communication

With structured shielded cabling CAT-5 cables should be used. This ensures a reliable operation at 10 Mbps or 100 Mbps.

The prerequisite for using TCP/IP protocol is that each device has a unique address on the network. All Readers have a factory set IP address.

Network	Address
IP-Adresse	192.168.10.10
Subnet-Mask	255.255.255.0
Port	10001
DHCP	OFF

Table 8 Standard factory configuration of the Ethernet connection

Note:



The Reader TCP/IP interface has a DHCP option.

More Information about the interfaces you will find in the manual "☞" **M81010-xe-ID-B** of the reader.



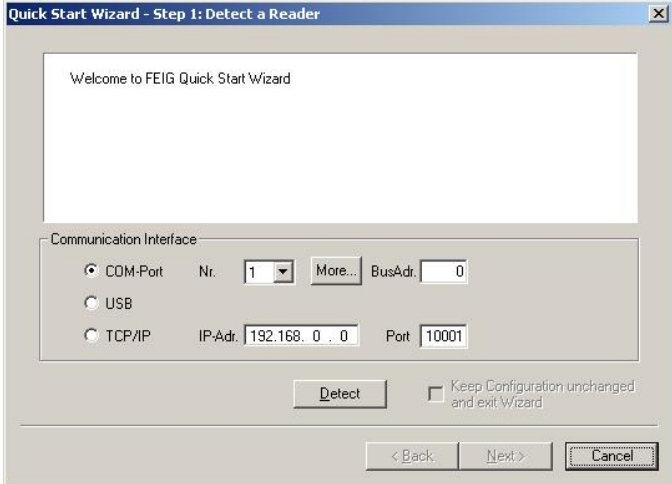
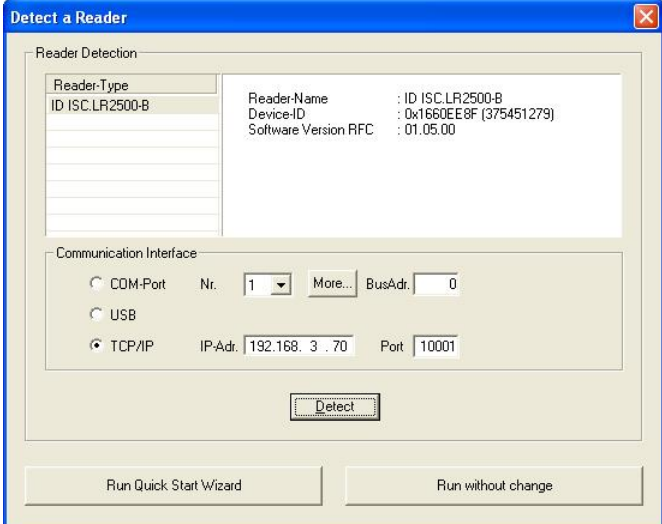
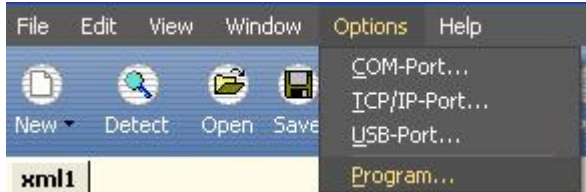

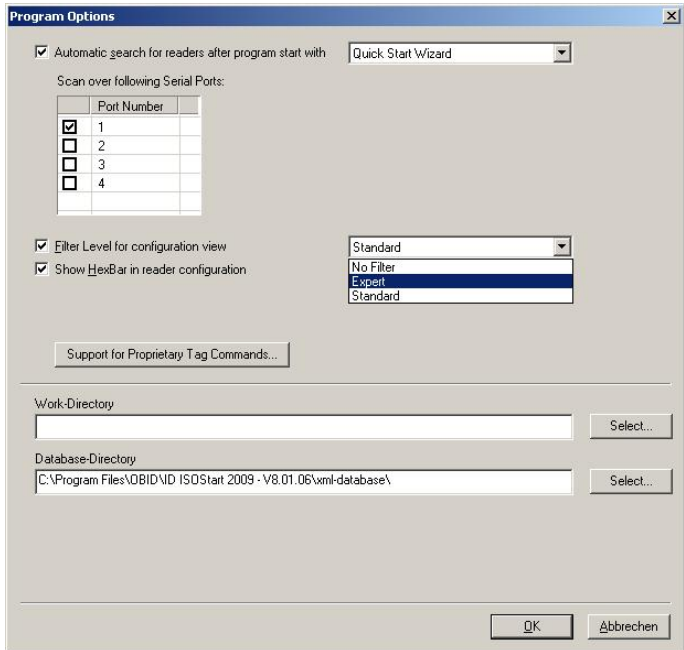
6.4.6 Reader Configuration with Multiplexer

To tune the antennas, open the ISOStart software and read out the current configuration of the Reader:

Step	Action	Note
1	Start ISO Start Software	
2	Select „Detect“	
3	Select „Run without change“ Note: This has to be done at each start of ISO-Start program otherwise the configuration of the reader will be changed by the wizard.	
4	Select „Options => Program“	

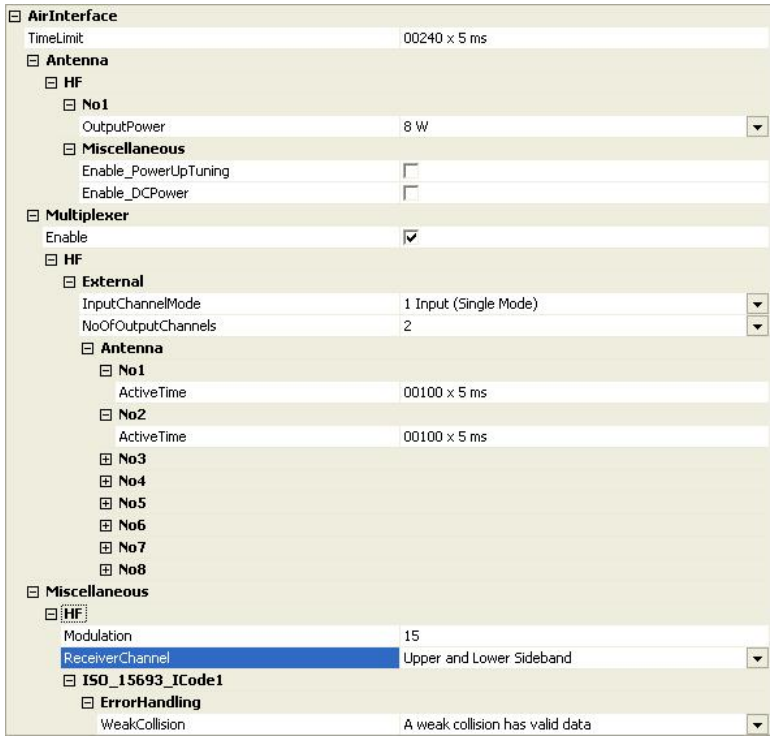

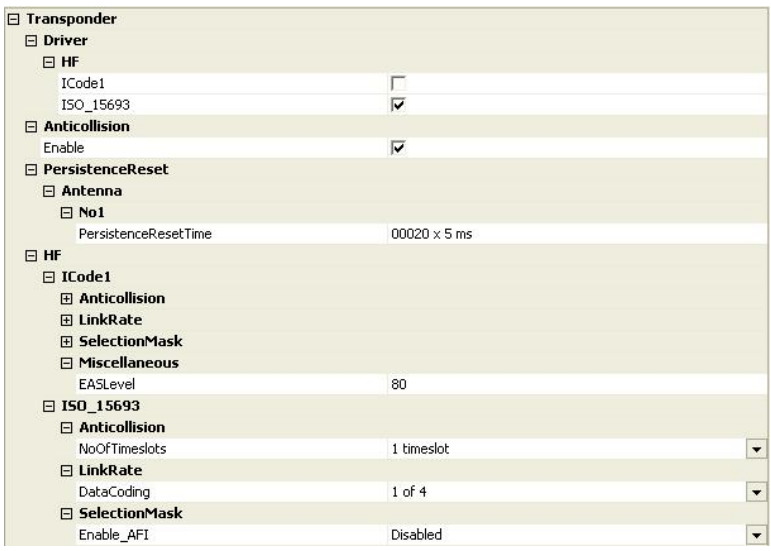
Step	Action	Note
5	Select „Expert Mode“ and confirm with OK.	
6	Select “Logical View”	

Afterwards set the operating power, Transponder Parameters and ISO Host Mode:

Step	Action	Note
1	Select "Configuration"	
2	<p>Air Interface:</p> <p>"Output -Power" = 8W „Multiplexer Enable“ „1 Input (Single Mode)“ „No of Output Channels „ (e.g. 2) „Antenna Active Time“ 100 x 5ms "Receiver Channel" Upper and Lower Sideband</p>	
3	Set by clicking on „Apply“.	
4	<p>Transponder:</p> <p>Configure the parameters as following:</p> <ul style="list-style-type: none"> • „Driver“ – here ISO 15693 • „Anticollision“ – enable • „No of Timeslots“ – 1 timeslot • „Data Coding“ – 1 of 4 • „AFI“ – Disabled 	 <p>Note: National RF regulations may require different settings. See: 8. Configure the reader in accordance with national RF regulations</p>
5	Set by clicking on „Apply“.	

6.4.7 Tuning the Gate Antenna

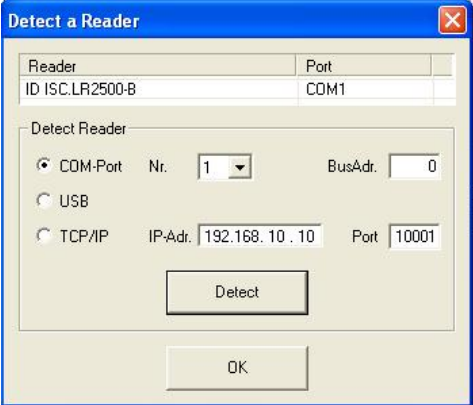
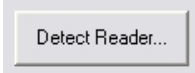
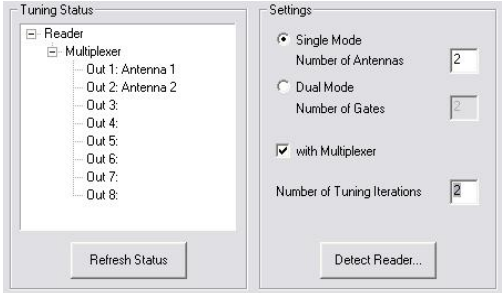
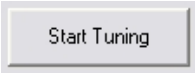
Before tuning the gate antenna, you must quit the ISOStart software. Then the gate can be tuned as follows:

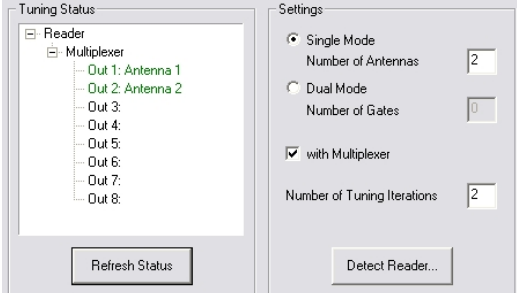
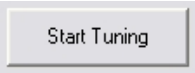



Step	Action	Note
1	Start "DATuningTool" software	
2	Select "Detect Reader...". In the „Detect Reader“ window select the interface (COM-Port 1, BusAdr. 0) and then click on "Detect".	 
3	Use „Settings“ to enter the configuration: Single Mode, Number of Antennas 2 Click on "with Multiplexer" Number of Tuning Iterations 3	
4	Activate „Start Tuning“ and wait until the tuning process is finished.	 
5	The tuning status is displayed after each tuning pass. After successful tuning both antennas are shown in green.	
6	If this does not succeed on the first try, start the process again by clicking on „Start Tuning“	

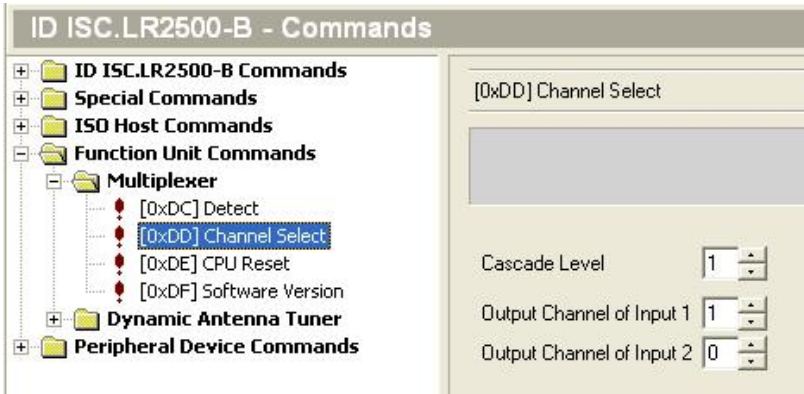

After successful tuning, close the DATuningTool.

6.5 Testing the Gate Antenna

After tuning the gate antenna, you can check for proper function using a reader, the ISOStart service software and a Transponder. Here the Noise Level and performance of the gate are tested.

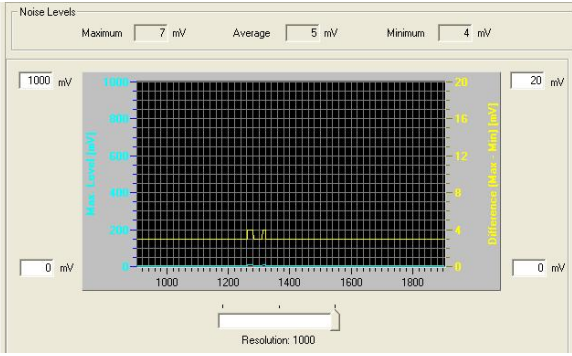
6.5.1 Checking the Noise Level

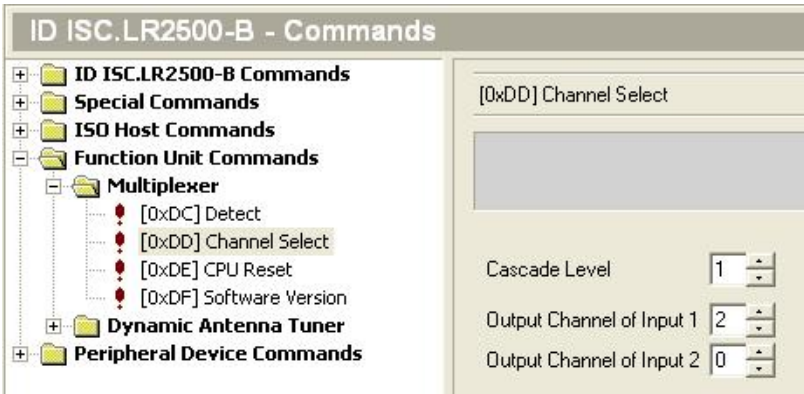
Step	Action	Note
1	Activate antenna 1 with command: „Function Unit Commands - Multiplexer“ Parameter: „Channel Select“ „Cascade Level = 1“ „Output Channel of Input 1 = 1“	
2	Confirm with “Send”	
3	Activate “Test and Measurement”	
4	Select „Noise Level“ and start by clicking on „Start“	
5	Normal Noise Level values: Average: < 30mV Difference (Max-Min): < 20mV	





Step	Action	Note
6	Activate antenna 2 with command: „Function Unit Commands - Multiplexer“ Parameter: „Channel Select“ „Cascade Level = 1“ „Output Channel of Input 1 = 2“	
7	Confirm with “Send”	
8	Repeat Step 3 to 5 for every further antenna	

If the values are not proper, check the following:

- Are all cables pulled tight and will contact well?
- Are the ring cores installed in the antenna cable?
- Are the cables routed as specified?
- Are other RFID systems installed closed by?
- Are there large metal parts close to the antenna (distance < 1.0 m)?
- Are there devices nearby which may emit noise interferences (larger machines or wireless devices)?
- Are there interferences from the mains?

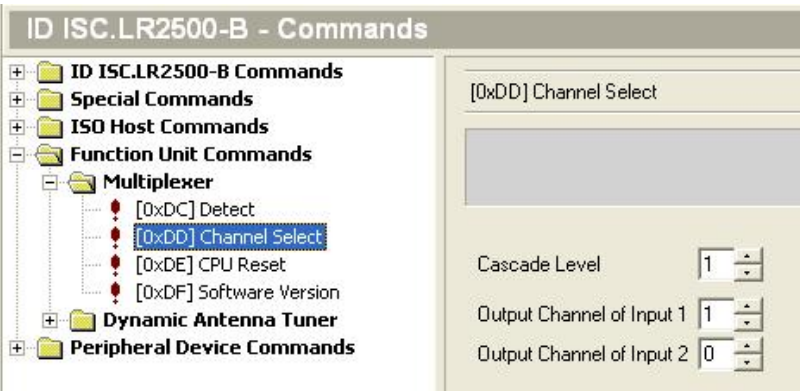
To determine which devices may be disturbing the gate, briefly disconnect them from the mains.

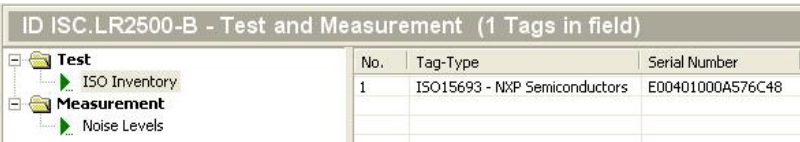
6.5.2 Reading a Serial Number

Step	Action	Note						
1	Attach a tag to an antenna Here to antenna at multiplexer output 1	Use adhesive tape, for example						
2	Activate antenna 1 with command: „Function Unit Commands - Multiplexer“ Parameter: „Channel Select“ „Cascade Level = 1“ „Output Channel of Input 1 = 1“							
3	Confirm with “Send”							
4	Select „Test and Measurement“							
5	Select „ISO Inventory“ function and activate by clicking on „Start“. The serial number and tag type will be shown in the display.	 <table border="1" data-bbox="986 1272 1442 1361"> <thead> <tr> <th>No.</th> <th>Tag-Type</th> <th>Serial Number</th> </tr> </thead> <tbody> <tr> <td>1</td> <td>ISO15693 - NXP Semiconductors</td> <td>E00401000A576C48</td> </tr> </tbody> </table>	No.	Tag-Type	Serial Number	1	ISO15693 - NXP Semiconductors	E00401000A576C48
No.	Tag-Type	Serial Number						
1	ISO15693 - NXP Semiconductors	E00401000A576C48						
6	Repeat Step 1 to 5 for every further antenna							

6.5.3 Testing the performance

For testing the performance you must switch the reader to one of the Automatic Modes.

[See 6.7 Activating the Automatic Mode](#)

A read transponder will be displayed by a blue LED on the reader, the Alarm LED light of the antenna and the Alarm sounder. See also [6.6.3 Reader Setting for Alarm Indicator](#)

In this test the capture area of the gate antenna described in [6.1 Project Notes](#) is checked. For other tags or other configurations the indicated ranges and read areas may differ accordingly.

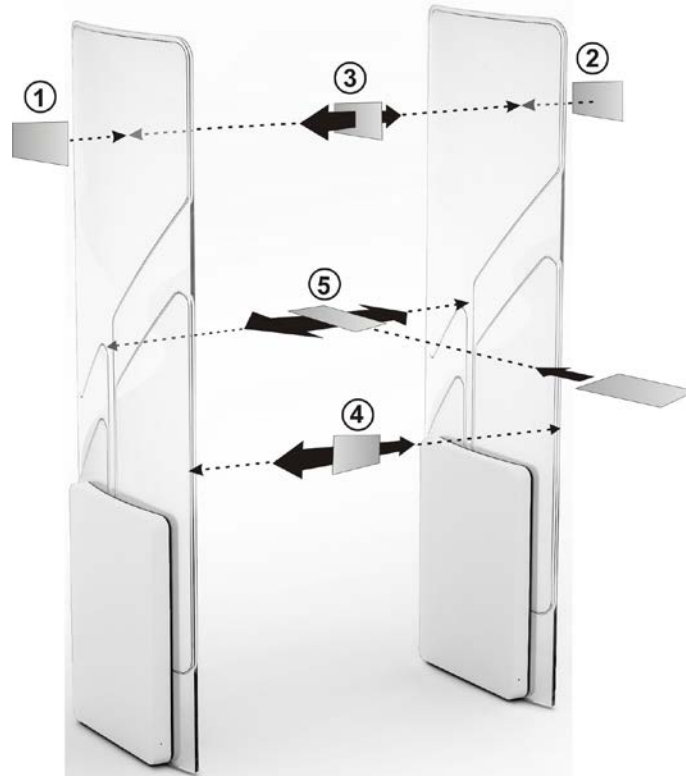

Fig. 24: Performance Test of the gate antenna

The test begins by checking the read range outside the gate (see Fig. points ① and ②), assuming the configuration and locality permit it. If the tag is oriented parallel to the antenna at the outside, a read range of 65 to 70 cm should be achieved.

The three tag orientations are checked inside the gate. This corresponds to the lines and orientations ③④⑤. Now slowly move the tag in the vertical and parallel direction with respect to the antenna along the line ③ from one side to the other. The tag should always be read.

Then repeat this along the line ④ in the vertical tag direction transverse to the antenna and on the line ⑤ in the horizontal tag orientation. Here again the tag should always be read.

The tag should be read within the gate by moving in a horizontal line through the gate in all three read orientations.

If one or more „holes“ are detected, check the noise values on the Reader (see [6.5.1 Checking the Noise Level](#)).

The following may result in faulty readings:

- Antenna improperly installed (orientation, antenna distance, check cabling)
- Metal near the antennas is detuning or interfering with them.
- The antennas are not properly tuned.
- Noise level too high ($V_{\max} - V_{\min} \geq 20 \text{ mV}$)
- Transponder too insensitive, detuned or defective
- Reader improperly configured (transmitting power, transponder type, modulation, transponder parameters, etc.).
- A cable is defect or has a weak contact.
- Reader, multiplexer or antenna defect.

6.6 Setting the Alarm Indicators (Alarm sounder and Alarm LED lights)

6.6.1 Setting the Buzzer

The solution provided here presumes that the alarm indicator (buzzer) is switched through the digital output 2 /X2 on the ID ISC.LRM2500-B reader. The pulse duration can be set (CFG2 / OUT2) between 100 ms and 65535 s by adjusting the Reader configuration. The volume of the buzzer could be adjusted by R1

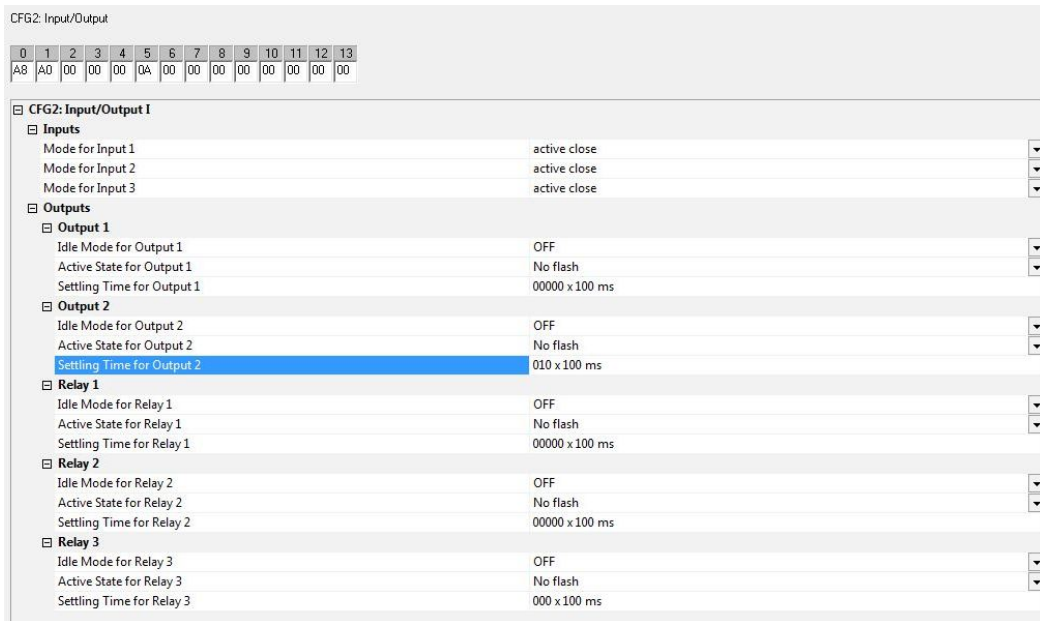

Fig. 25 Configuration Buzzer

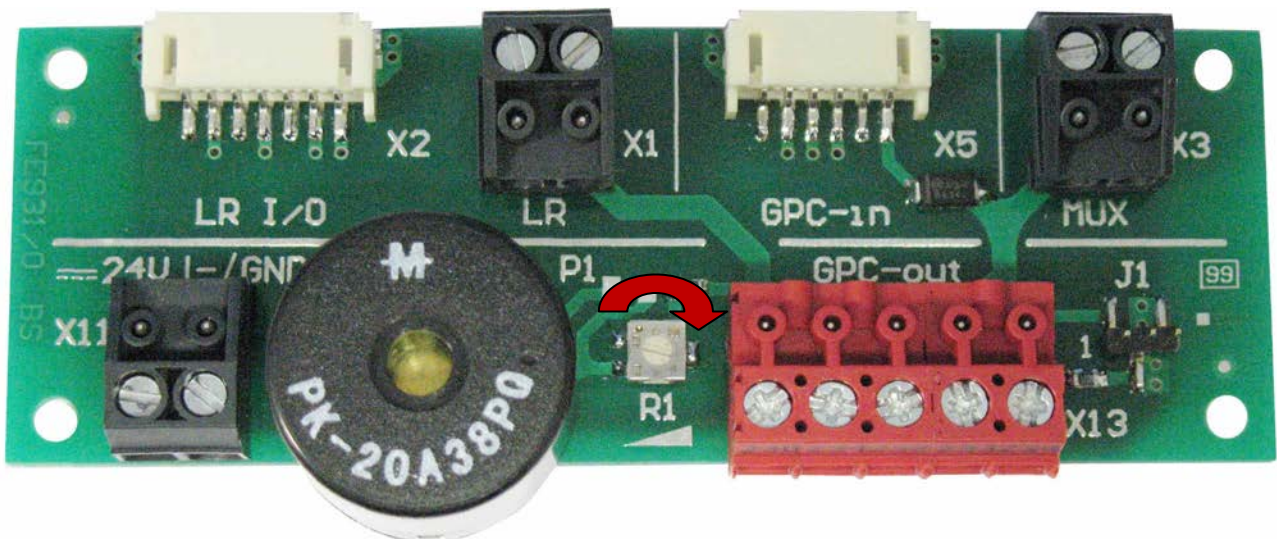

Fig. 26 Volume adjusting

6.6.2 Setting the LED's

The alarm LED's will be switched by a command of the reader over the RS485 Bus.
Due to that reason the terminal boards of all used antennas have to be connected 1:1 in parallel together.

The Bus address for each LED will be defined by the antenna number it is installed in.
The antenna number depends on the output of the Multiplexer the antenna is connected to.

The Bus address will be set automatically in one of the automatic modes.

See also [6.8 Automatic Bus addressing](#)





The successful detection of the connected LED's could be checked
with the command "Get Reader Info"



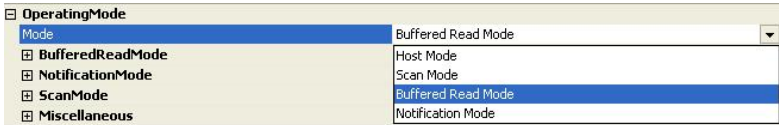
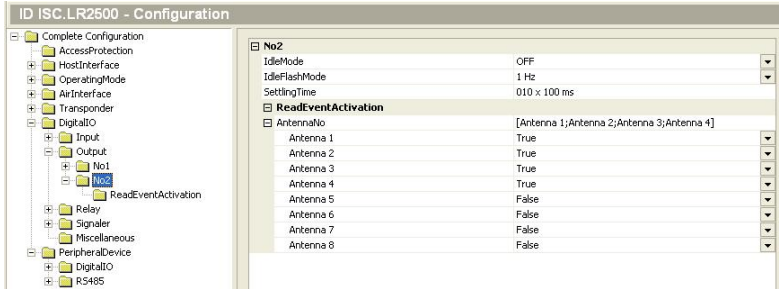

LED in Antenna No.	Connected to Multiplexer Output No.	Bus Address No.
1	1	11
2	2	12
3	3	13
4	4	14
5	5	15
6	6	16
7	7	17

Table 9

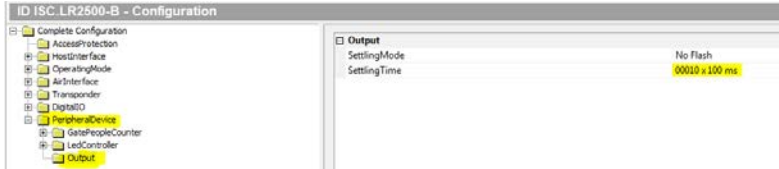
6.6.3 Reader Setting for Alarm Indicators

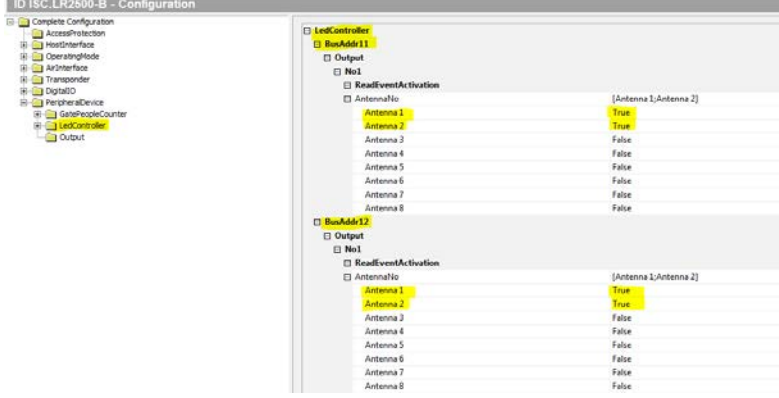
The ISOStart software can be used to set the Reader configuration so that the output 2 X6-1/-2 opens or closes or the LED’s get a command when a Transponder is read.

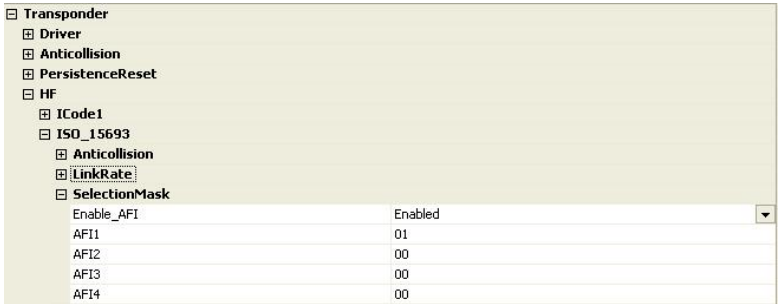
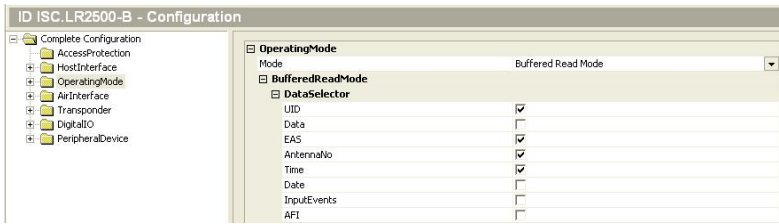



Step	Action	Note
1	Start ISOStart Software	 ISOStart.exe
2	Select “Configuration” and click on “Read” to read the complete configuration.	 
3	Operating Mode Select Buffered Read Mode.	
4	Digital IO: Output Idle Mode: OFF Idle Flash Mode: 1Hz Setting Time: with „Setting Time“ set time of output 2 for alarm duration. (10 means 1 second) (e.g. 10 x 100ms) Assign Output 2 to antenna 1+2. „True“ means: Output 2 will be active if the reader reads a valid transponder.	
5	Set by clicking on „Apply“.	
6	Peripheral Device LED Controller: Setting Time: „Setting Time“ set the duration time for the alarm. (10 means 1 second) (e.g. 10 x 100ms)	

	<p>Assign LED Bus Address 11 to antenna 1. LED Bus Address 12 to antenna 2. and so on.</p> <p>„True“ means: LED with Bus Address 11, 12, ... 17 will be active if the reader read a valid transponder on the corresponding antenna</p>	
<p>7</p>	<p>Set by clicking on „Apply“</p>	
<p>8</p>	<p>Transponder</p> <p>If the alarm should occur by a transponder with valid AFI byte, you have to configure the reader as follow:</p> <p>ISO-15693 – Selection Mask</p> <p>Set “Enable AFI”</p> <p>Set the value for the AFI in field “AFI1” (e.g. 01)</p> <p>Note:</p> <p>Up to four different AFI values could be set.</p>	
<p>9</p>	<p>Operating Mode</p> <p>If the alarm should occur by an EAS, you have to configure the reader as follow:</p> <p>Set “EAS”</p>	
<p>10</p>	<p>Set by clicking on „Apply“</p>	

6.6.4 Programming a Transponder with the AFI Byte

If the Transponders will remain on the object when leaving the storage location, they must first be disabled. This is generally done by writing to a particular area of the Transponder.

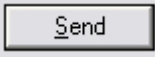
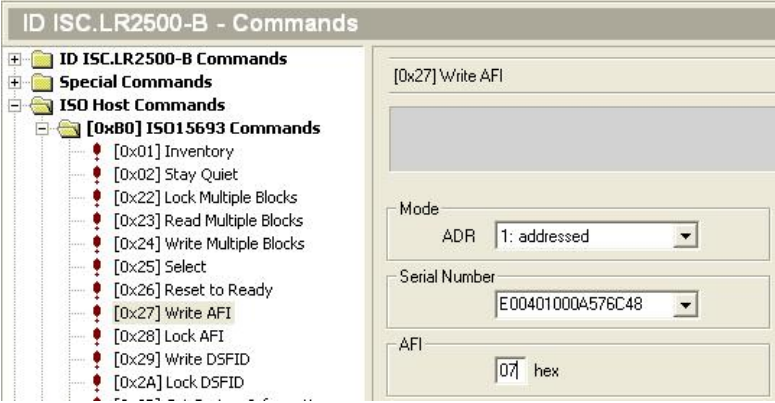
The AFI byte (Application Family Identifier) is useful for this purpose, since it is contained in nearly all Transponder models in the ISO15693 family. To disable, simply write a different code to the Transponder than for valid Transponders which trigger an alarm.

Step	Action:	Note:
1	Select „Commands“	
2	Place the Transponder in the antenna field (Antenna 1) Select [0x01] Inventory Mode: “New Inventory Requested”	
3	Read UID by clicking on „Send“	
4	The serial number, DSFID and Transponder type are displayed in a window. Write down the serial number of the Transponder	<pre data-bbox="679 1155 1449 1361"> [0xB0] [0x01] Read Serial Number Statusbyte: 0x00 (OK) 1 Transponder in Protocol 1. Transponder TR-TYPE.....: 0x03 (ISO15693 - Philips Semiconductors) DSFID.....: 0x00 SNR.....: E00401000003165C </pre>
5	Select „[0x27] Write AFI“ ADR: 1: addressed Serial Number: Select Transponder UID AFI: Desired AFI Number (not equal to 00)	
6	Write AFI byte on to the transponder by click on „Send“	

7	<p>To verify, read AFI byte by using the command</p> <p>[0x2B] Get System Information</p>	
---	---	--

6.7 Activating the Automatic Mode

The gate has to be used in one of the Automatic Modes (Buffered Read or Notification Mode) to get a maximum performance. Otherwise the reading performance will be significantly reduced.

For more information, see System Manual [H01112-0e-ID-B.pdf](#) ID ISC.LRM2500-A/B

Which mode the most suitable is for your application has to be defined in advance.

In this example it is described how to activate the Buffered Read Mode.

In the automatic modes, the tags are read at maximum speed and the information is stored in the ring buffer of the reader. Data set can be read by the host.

Due to the automatic alarm features at the automatic mode, the reader/gate can also run without any interface connection (Serial, Ethernet).

To activate „Buffered Read Mode“ proceed as follows:

Step	Action	Note
1	Select „Configuration“	 Configuration
2	<p>Operation Mode: „Mode“ - Buffered Read Mode „Data Selector“ -UID -Antenna No -Time -Date</p> <p>„Filter“ Set Transponder Valid Time. (e.g. 55 x 100ms)</p>	
3	Set clicking on „Apply“	



Note:

The configuration of the Notification or Scan Mode are similar (See System Manual of the reader)
 To test the function of the Gate in the Buffered Read Mode, the BRM Window of ISOStart or the BRMDemo program can be used.

6.8 Automatic Bus addressing

The automatic bus addressing should be done after setup, configuring and **tuning** the gate antenna.

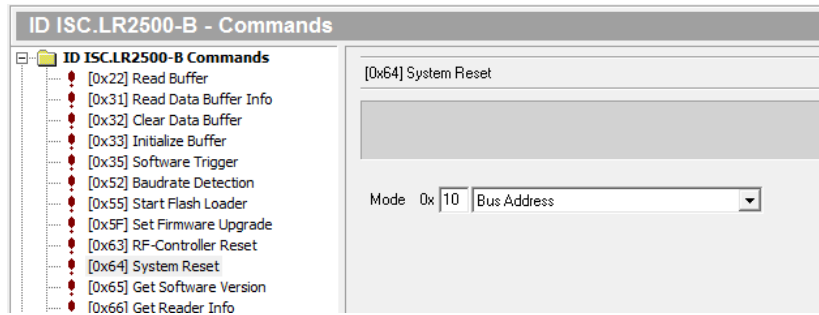
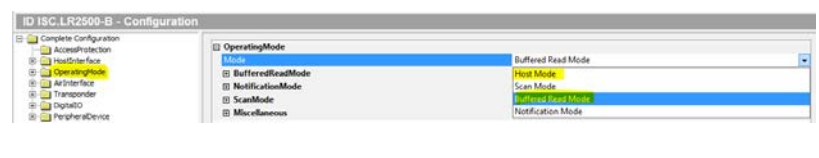
The automatic bus addressing will be done after the following conditions:

Step	Action	Note
1	Send a command "System Reset" Mode 0x10 Bus Address In one of the automatic modes.	
2	Changing the operation Mode from ISO-Host to Buffered Read or Notification Mode	
3	Changing the number of output channels of the multiplexer if reader is in one of the automatic modes.	

After the automatic bus addressing the right addressing will be signaled by the LED of the antennas

- ➔ Only LED installed. LED will switched on "Red" at the corresponding antenna. (Should be antenna number 2,3,5,7)
- ➔ LED and GPC installed. LED will flash "RED" at the corresponding antenna. (Should be antenna number 1,4,6) **2.GPC must be installed in antenna No.4 and 3.GPC in antenna No.6 otherwise the automatic Bus addressing will fail !**
- ➔ Here it also could be check if antennas are connected to the right output of the Mux.

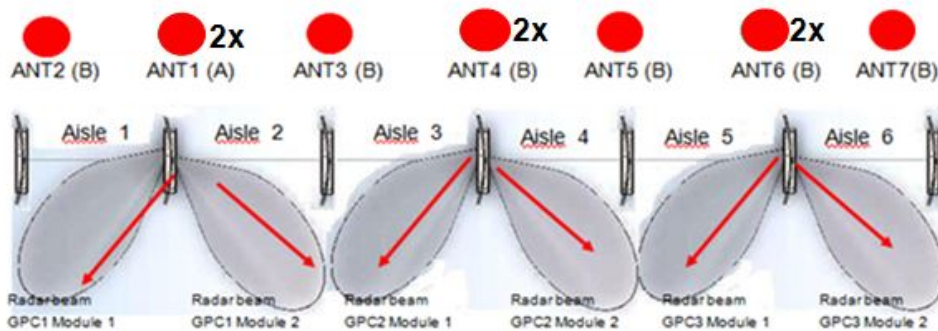

6.9 Installation ID ISC.ANT.GPC-E2

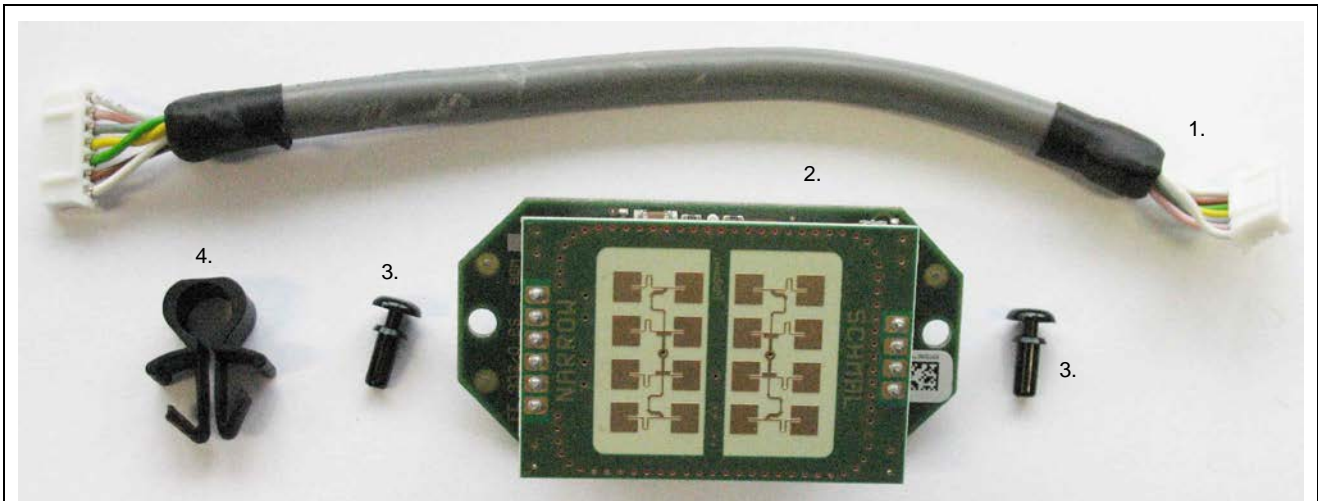

<p>Content of the ID ISC.ANT.GPC-E2</p>	<ul style="list-style-type: none"> 1. 1 piece Radar connection cable 2. 1 piece Radar module 3. 2 piece split rivet 3,0mm 4. 1 piece cable-clip
---	---

Step	Action	Note
<p>1.</p>	<p>Attention !!</p> <p>Note: Do not touch the antenna surface of the Radar module to avoid damaging the electronic components and soiling.</p>	
<p>2.</p>	<p>Connect radar connection cable with X1 of Radar module.</p>	

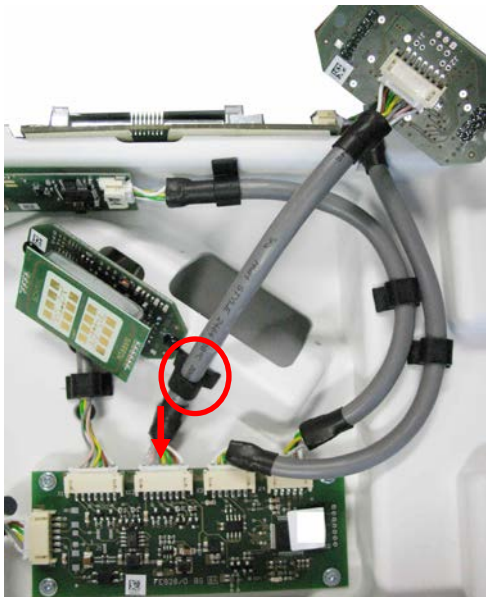
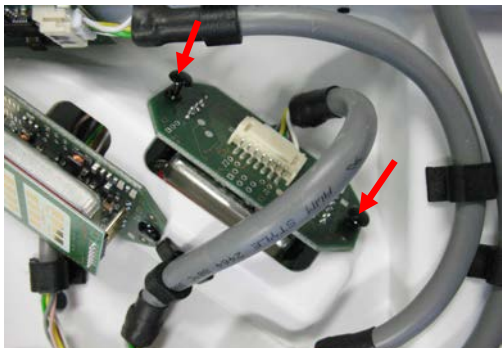
<p>3.</p>	<p>Plug Radar connection cable into X12 Sen 2 and fix the cable with the cable clip.</p>	
<p>4.</p>	<p>Install Radar module with the two split rivets See picture</p>	
<p>5.</p>	<p>The sensitivity of the radar module will be set automatically by the GPC after power up the gate system.</p>	<p>To check/set the sensitivity see also 7.2.2 Configuration and Test in ISO-Host or Buffered Read Mode , Step 8</p>

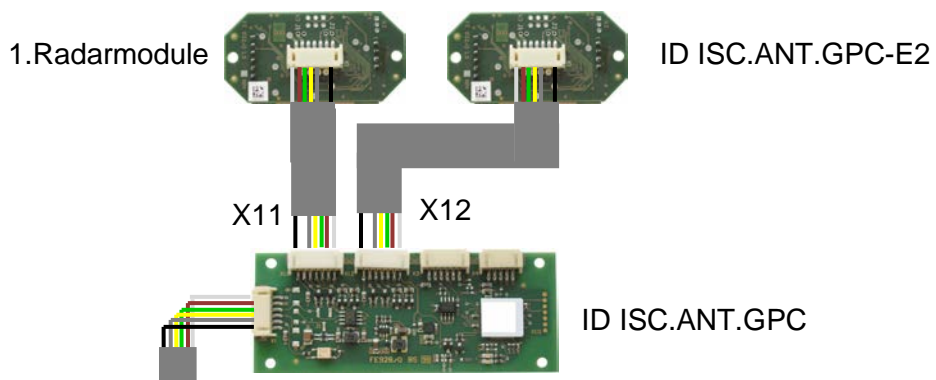
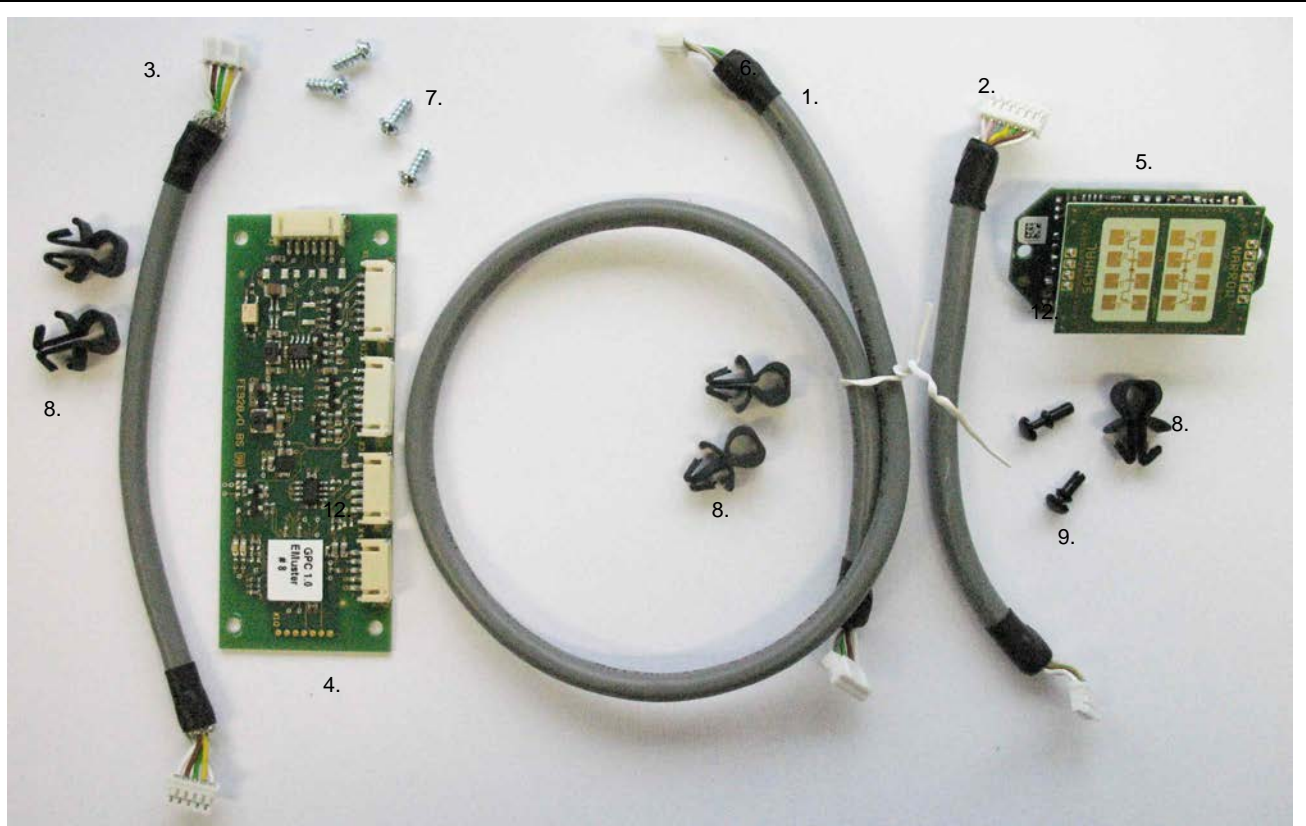

Fig. 27: Connections GPC-2E 2. Radarmodule

7 Installation of the Gate People Counter ID ISC.ANT.GPC in antenna Type B

7.1 Installation and Connections



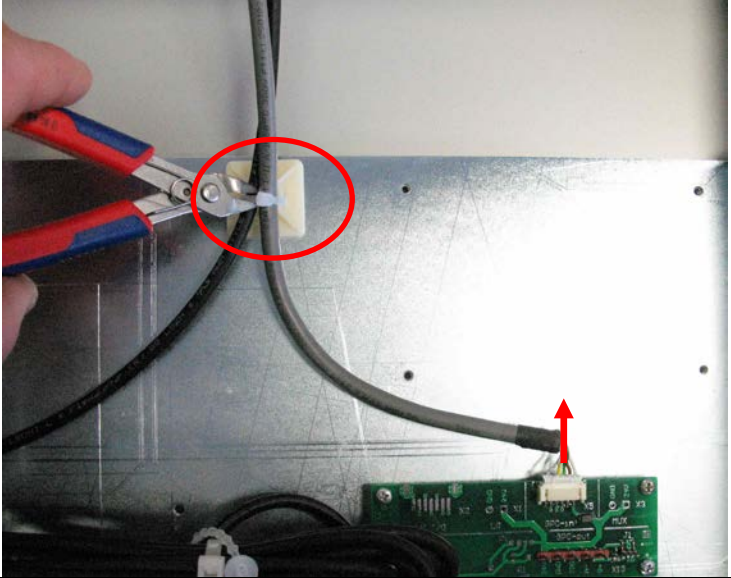
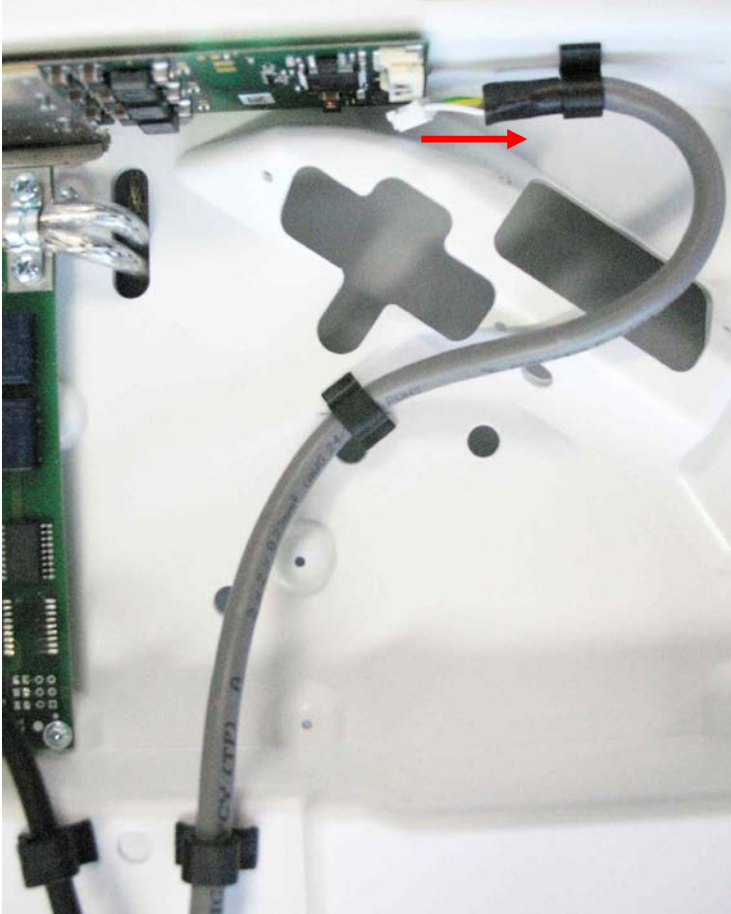

Contents of the ID ISC.ANT.GPC

1. 1 piece connection cable People Counter –Terminal board
2. 1 piece Radar connection cable
3. 1 piece LED connection cable
4. 1 piece People Counter Board
5. 1 piece Radar module
6. 1 piece cable tie
7. 4 piece screw for plastic 3x12mm
8. 5 piece cable-clip
9. 2 piece split rivet 3,0mm
10. 1 piece FCC / IC Label

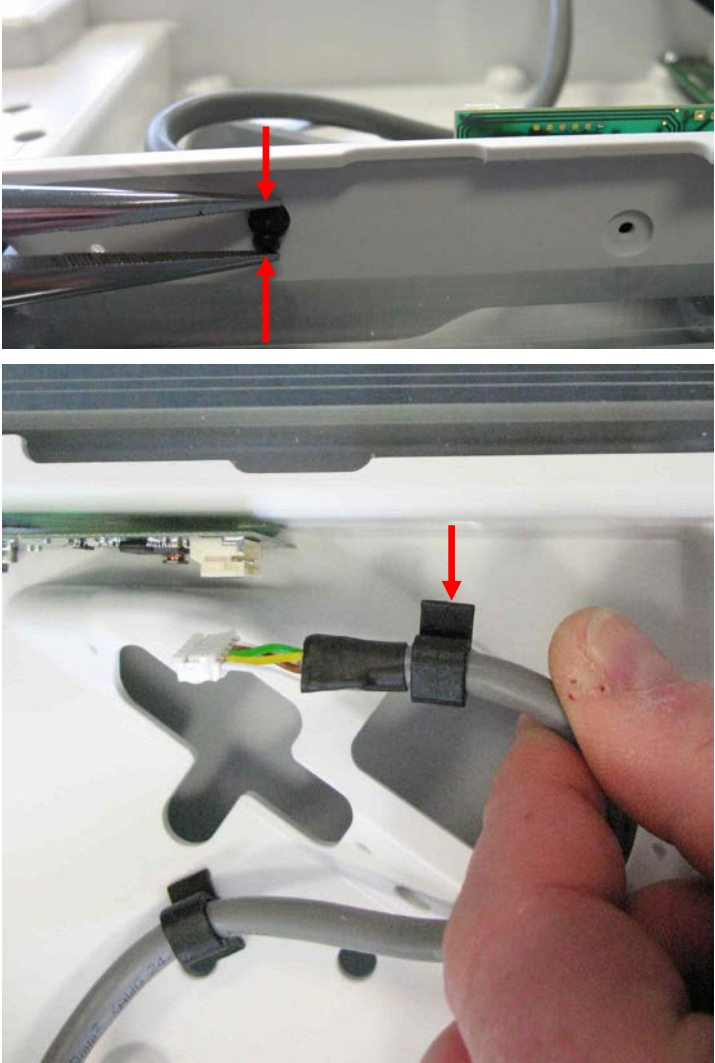
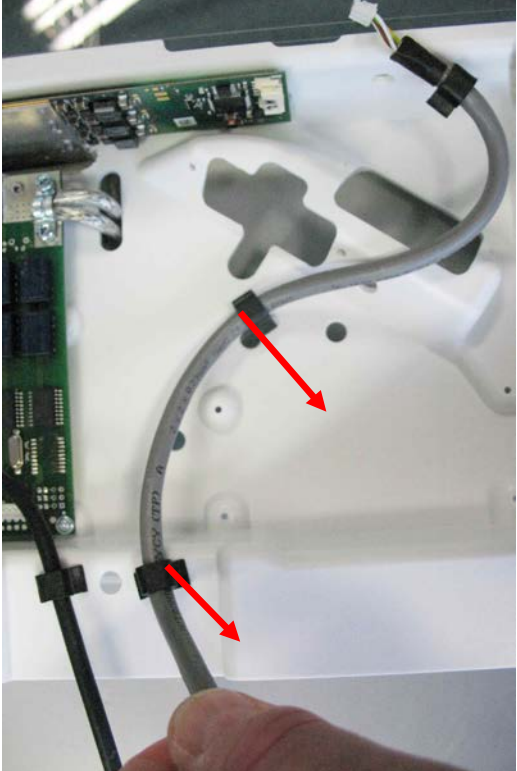

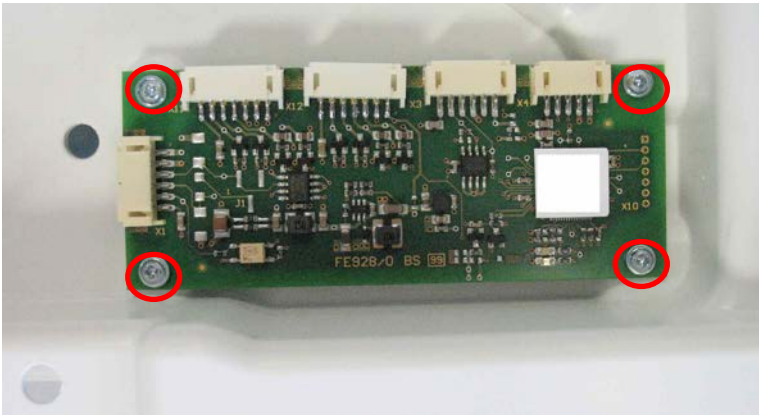
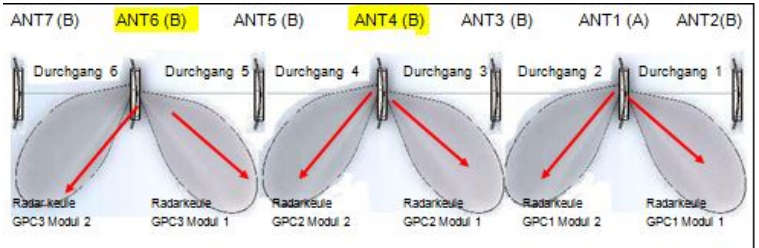
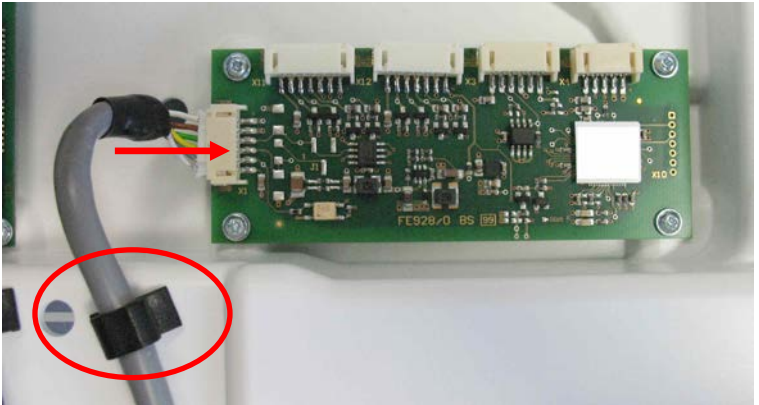
Step	Action	Note
1.	Disconnect LED connection cable at the terminal board and cut the cable tie in the antenna foot.	
2.	Disconnect LED connection cable at LED controller.	

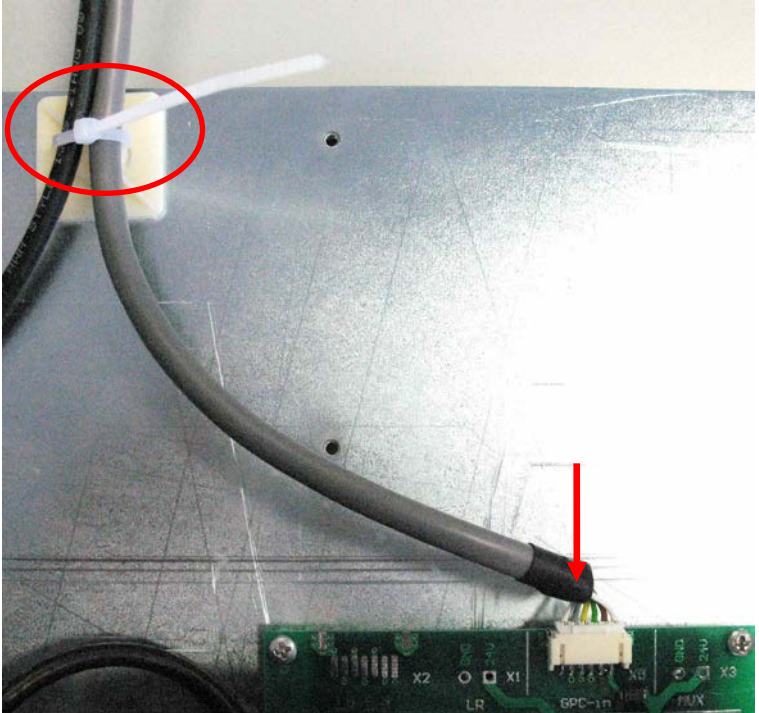
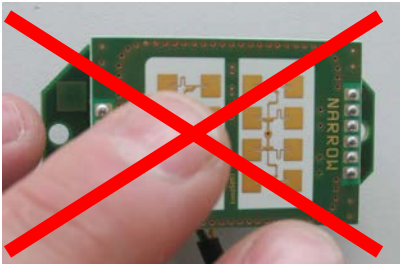
<p>3.</p>	<p>Remove the cable clip beside the LED controller.</p>	 <p>The top photograph shows a pair of pliers being used to pull a black plastic cable clip away from a grey cable. Two red arrows point to the clip. The bottom photograph shows a hand pulling a similar black plastic cable clip from a grey cable that is connected to a green printed circuit board (PCB). A red arrow points to the clip.</p>
<p>4.</p>	<p>Remove the 2 other cable clips by pulling them out with the cable.</p>	 <p>The photograph shows a grey cable with two black plastic cable clips attached. A hand is pulling the cable, and two red arrows point to the clips, indicating they should be removed by pulling the cable.</p>

<p>5. Install People Counter Board into antenna with screws for plastic in antenna No.4 and No.6 The 2.GPC must be installed in ANT No.4 and the 3.GPC in ANT No.6 otherwise the Automatic Bus Addressing will fail !</p>	 
<p>6. Plug GPC connection cable onto X1 at GPC and X5 GPC-in at terminal board and fix it with two cable clips and the cable tie.</p>	

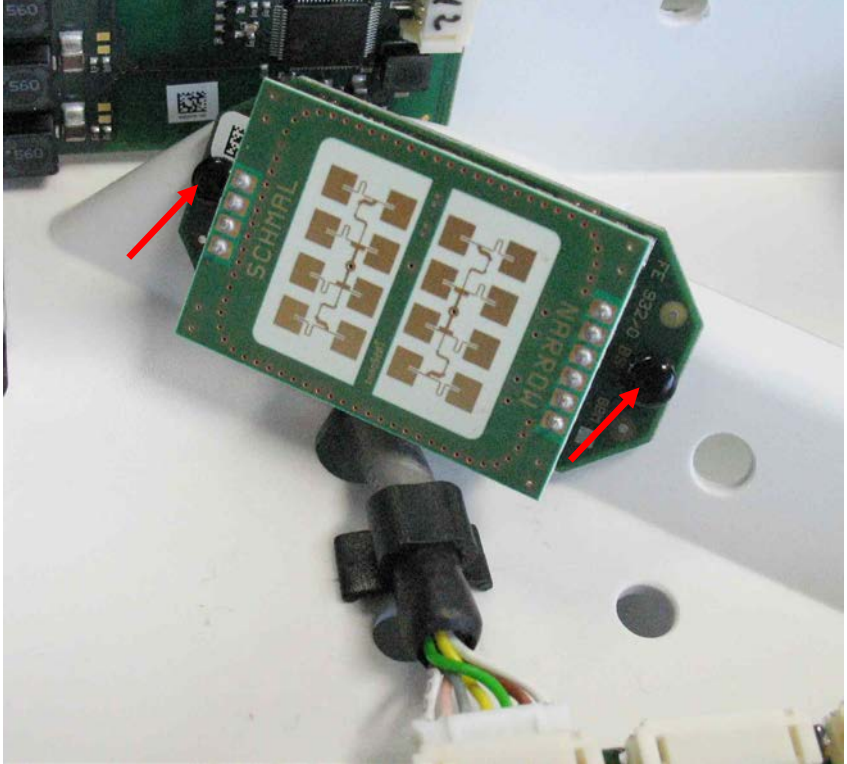
		
<p>7.</p>	<p>Attention !! Note: Do not touch the antenna surface of the Radar module to avoid damaging the electronic components and soiling.</p>	
<p>8.</p>	<p>Connect radar connection cable with X1 of Radar module.</p>	

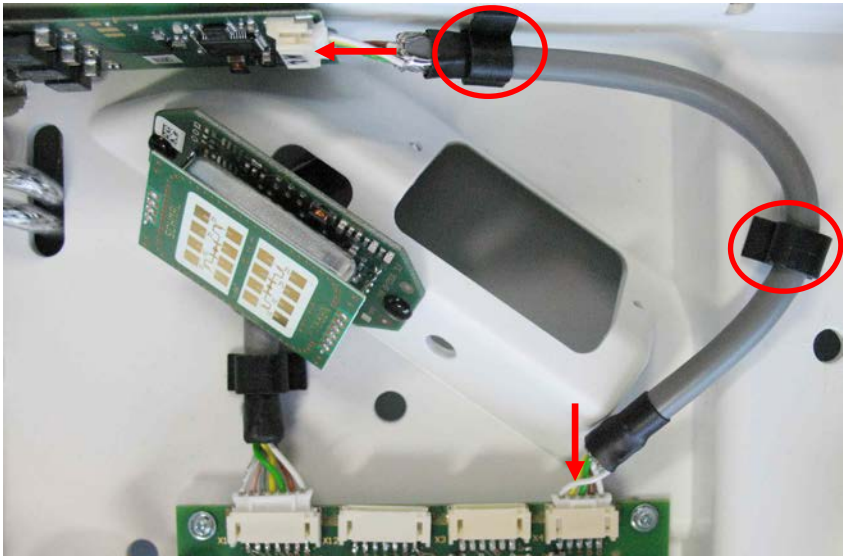
<p>9.</p>	<p>Plug Radar connection cable onto X11 Sen 1 at GPC and fix the cable with the cable clip.</p>	
<p>10.</p>	<p>Install Radar module with split rivet. Use installation hole that radar module surface faces between the antennas.</p>	
<p>11.</p>	<p>The sensitivity of the radar module will be set automatically by the GPC after power up the gate system.</p>	<p>To check/set the sensitivity see also 7.2.2 Configuration and Test in ISO-Host or Buffered Read Mode , Step 8</p>

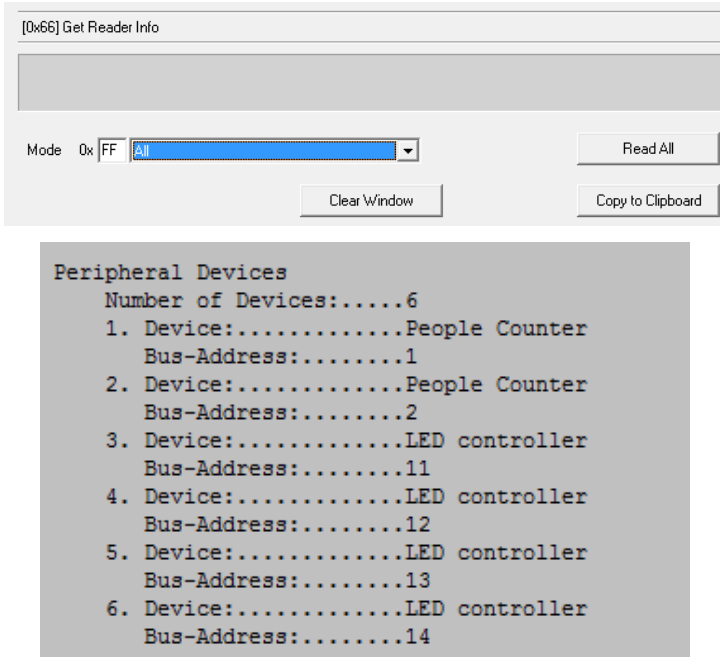
<p>12.</p>	<p>Connect LED cable with X1 of LED controller and fix it with the cable clips. Connect the LED cable with X3 of GPC</p>	
<p>13.</p>	<p>Close antenna with antenna cover with display window After the installation you have to stick the adhesive label of the GPC below the type plate of the antenna.</p>	 <div data-bbox="1050 949 1442 1149" style="border: 1px solid black; padding: 5px;"> <p>contains TX-Module with IC: 6633A-GPC and FCC ID: UXS-IPS154US</p> </div>
<p>14.</p>	<p>The detection of the 2.and 3. GPC will be automatically done after power up the gate system or the command "System Reset" in one of the Automatic modes. The successful detection could be checked with the command "Get reader Info" "Read All" and will also be displayed at the LCD-display after power up or command "System Reset"</p>	 <pre> Peripheral Devices Number of Devices:.....6 1. Device:.....People Counter Bus-Address:.....1 2. Device:.....People Counter Bus-Address:.....2 3. Device:.....LED controller Bus-Address:.....11 4. Device:.....LED controller Bus-Address:.....12 5. Device:.....LED controller Bus-Address:.....13 6. Device:.....LED controller Bus-Address:.....14 </pre>

7.2 Configuration and Test

To activate the People Counters the following settings has to be done.

Set additionally the Jumpers JP10 and J11 of Reader ID ISC.LRM2500-B to configure the RS485 interface. "☞" (see also manual M81010-xe-ID-B , page19 and 20). The Termination has to be activated via software in the reader configuration.

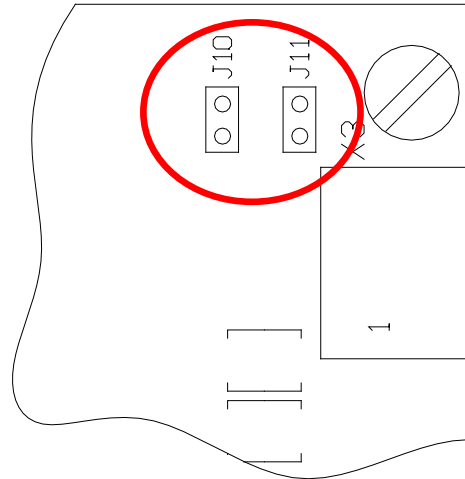
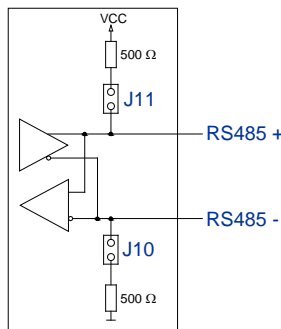

Fig. 28: Jumper settings RS485 Interface

7.2.1 Connecting several People Counter

When using several People Counters (up to 3), at one reader, you have to connect the terminal boards of all used antennas with each other in parallel. For the connection you have to use 5 (6) pin shielded, twisted-pair cable. Example: LiYCY (TP) 3x2x0,25 .

The cable (2.5m) is contents of antenna Type B

The Bus address of the People Counter will be defined by the antenna number it is installed in.

GPC1 in Antenna No.1 = Bus address No. 1





GPC2 in antenna No.4 = Bus address No. 2



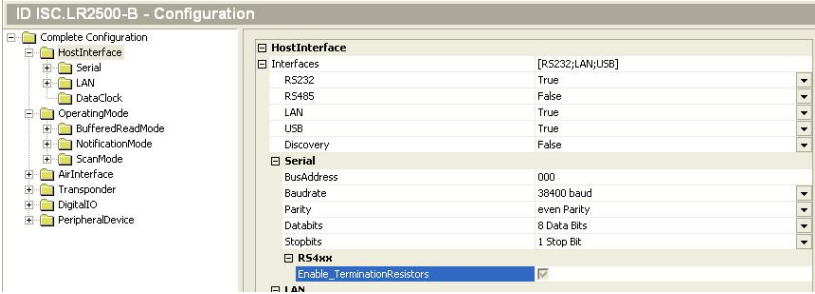

GPC3 in antenna No.6 = Bus address No. 3

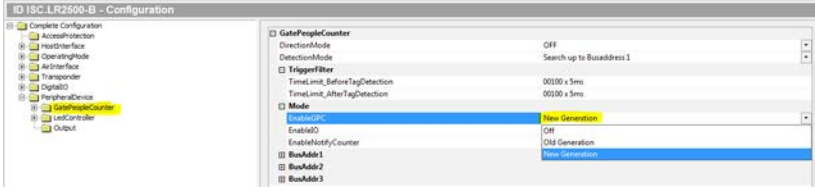

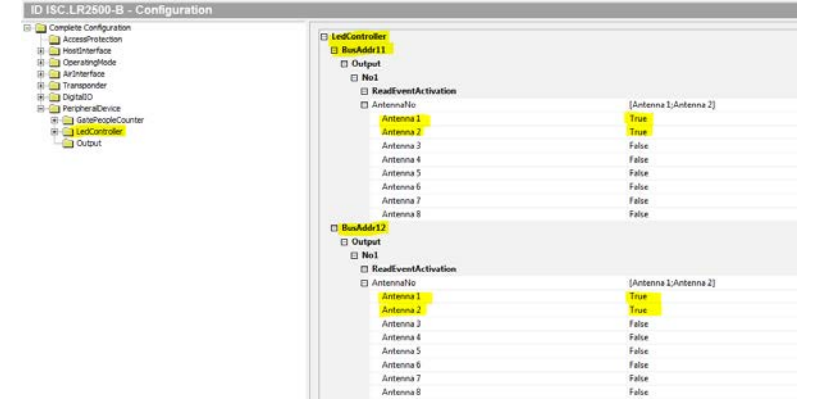

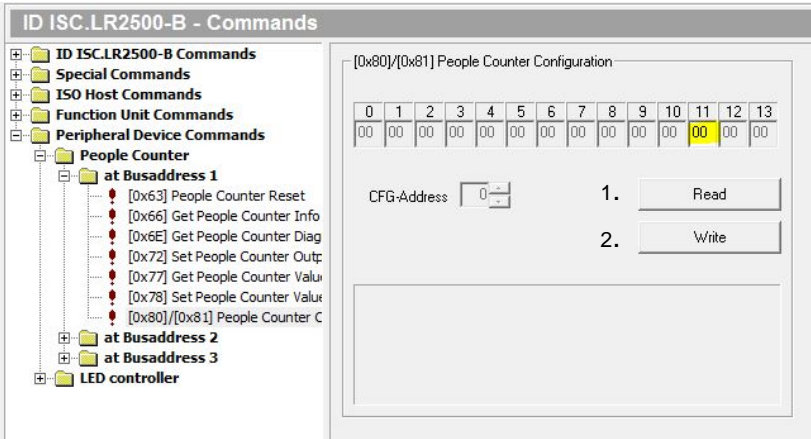

The Bus address will be set automatically after a command "System Reset" in one of the automatic modes. See also [6.8 Automatic Bus addressing](#)

The successful detection of the connected Gate People Counter could be checked with command "Get Reader Info"

7.2.2 Configuration and Test in ISO-Host or Buffered Read Mode

Step	Action	Note
1	Select „Configuration“	
2	<p>Host Interface Set RS 485 to “False” and „Enable Termination Resistors“</p> <p>The RS232/485 Settings should be set to: Busaddress=0, Baudrate=38400 baud, Parity = even , Number of Databits = 8, Number of Stopbits = 1</p>	
3	Confirm with „Apply“	
4	<p>Peripheral Devices Gate People Counter Mode Enable GPC to „New Generation“</p>	
5	Confirm with „Apply“	
6	<p>Peripheral Device LED Controller: Setting Time: „Setting Time“ set the duration time for the alarm. (10 means 1 second) (e.g. 10 x 100ms)</p> <p>Assign LED Bus Address 11 to antenna 1. LED Bus Address 12 to antenna 2. and so on.</p> <p>„True“ means: LED with Bus Address 11, 12, ... 17 will be active if the reader read a valid transponder on</p>	

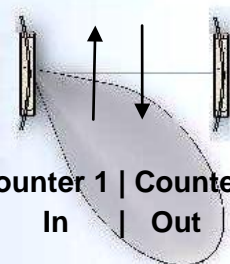
	the corresponding antenna	
7	Set by clicking on „Apply“.	
8	<p>The sensitivity of the connected radar modules could be set by</p> <ul style="list-style-type: none"> - Peripheral Device Commands, section, - People Counter at Busaddress 1,2 and 3 - Byte 11: <ul style="list-style-type: none"> 00 = Low 05 = Middle 0A = High (Default) 0F = Very high <p>First “Read” out actual setting of sensitivity. If needed change to new sensitivity by “Write” the new value into the GPC.</p> <p>A “People Counter Reset” command must be sent to confirm the change, otherwise the sensitivity will not change.</p>	 
	Test: People Counter	
9	Select „Commands“	
10	<p>Select Command</p> <ul style="list-style-type: none"> - „Get Reader Info“ - Peripheral Devices 	

<p>11</p>	<p>Confirm with „Send“ Number of Devices should be 1</p>	
<p>12</p>	<p>Select Command „Set People Counter Values“</p>	
<p>13</p>	<p>Confirm with „Send“</p>	
<p>14</p>	<p>Select Command „Get People Counter Values“</p>	
<p>15</p>	<p>Confirm with „Send“ All counter values should be 0</p>	
<p>16</p>	<p>Walk through the gate from both directions.</p>	
<p>17</p>	<p>Select Command „Get People Counter Values“</p>	
<p>18</p>	<p>Confirm with „Send“</p>	

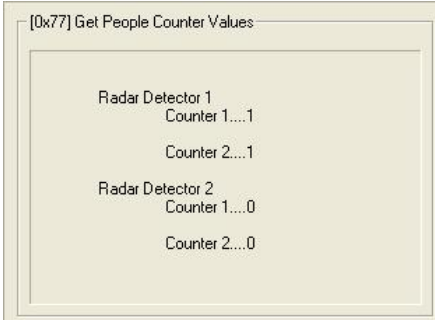



<p style="text-align: center;">19</p>	<p>Counter values will be displayed.</p>	 <p>The screenshot shows a window with the title "[0x77] Get People Counter Values". Inside the window, there are two sections of text:</p> <ul style="list-style-type: none"> Radar Detector 1 <ul style="list-style-type: none"> Counter 1...1 Counter 2...1 Radar Detector 2 <ul style="list-style-type: none"> Counter 1...0 Counter 2...0
--	--	--

In ISO-Host and Buffered Read the People Counter has to be polled by the Host Application to get the data.

In Notification Mode the Reader sends the People Counter Data automatically to the Host.

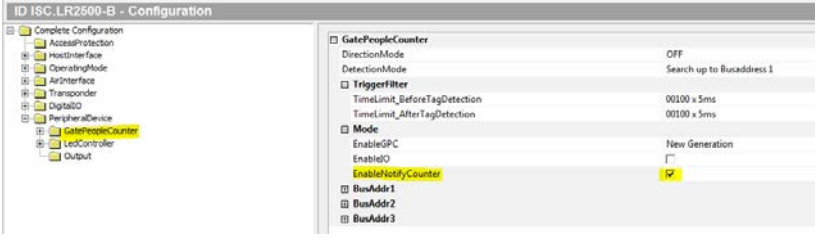
7.2.3 Configuration and Test in Notification Mode

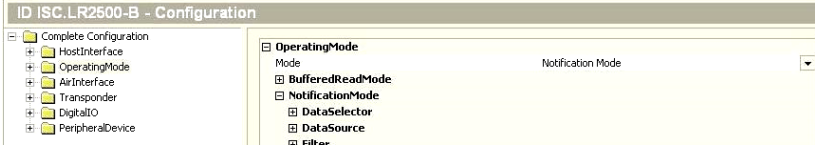
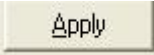
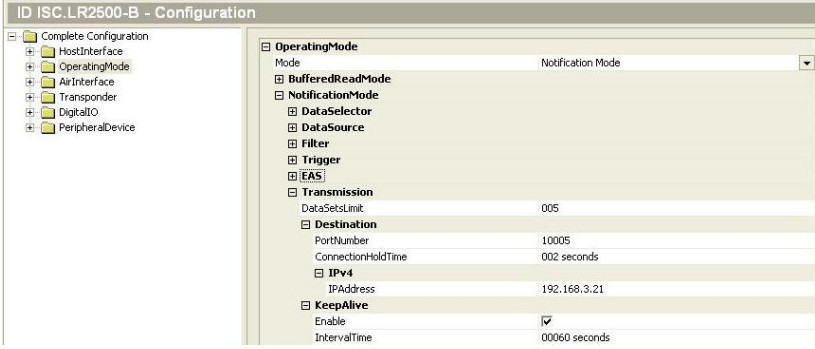
The following configuration has to be done:

Step	Action	Note
1	Select „Configuration“	
2	<p>Peripheral Devices GPC Mode</p> <p>Set “Enable Notify Counter”</p>	
3	Confirm with „Apply“	
4	<p>Operating Mode</p> <p>Select -Notification Mode</p>	
5	Confirm with „Apply“	
6	<p>Set IP Address and Port for Notification Mode</p> <p>IP Address of Host e.g. here: 192.168.3.21</p> <p>Port:10005</p> <p>The same TCP/IP Address and Port Address is valid for the Notification Chanel of the People Counter and Notification Chanel of the data</p>	
7	Confirm with „Apply“	

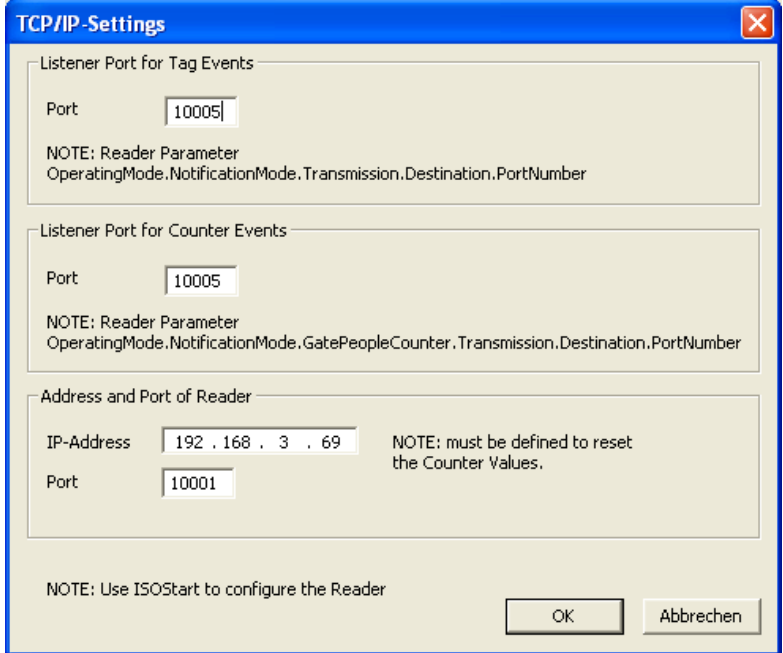
<p>8</p>	<p>A Test could be done with the People Counter Sample.</p>	
<p>9</p>	<p>Therefore you will have to set both ports have the same address, at the TCP-Settings.</p>	

7.2.4 Using the trigger function of the Gate People Counter

 The trigger function could only be used in one of the Automatic Modes.

The trigger function works bidirectional, but a 100% safe reading of transponder is only possible from one direction. Due to this, it is necessary at the installation of the antennas, that the Radar module / Antenna faces to the direction of the transponder which could cause the alarm. At buildings (e.g. Libraries) the Radar module faces into the building. Otherwise the reading of the transponder will just be started, when the person/transponder is already in or outside the gate.

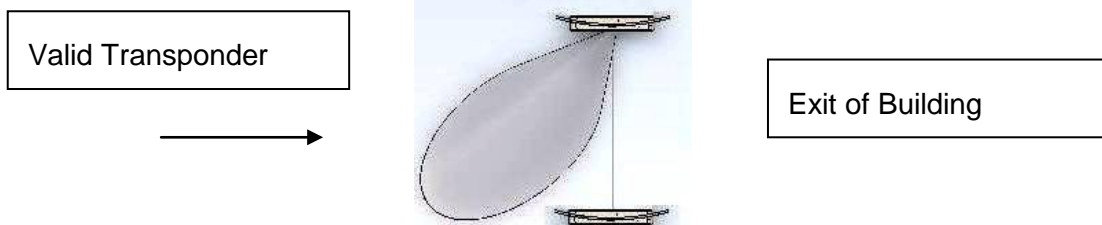

Fig. 29

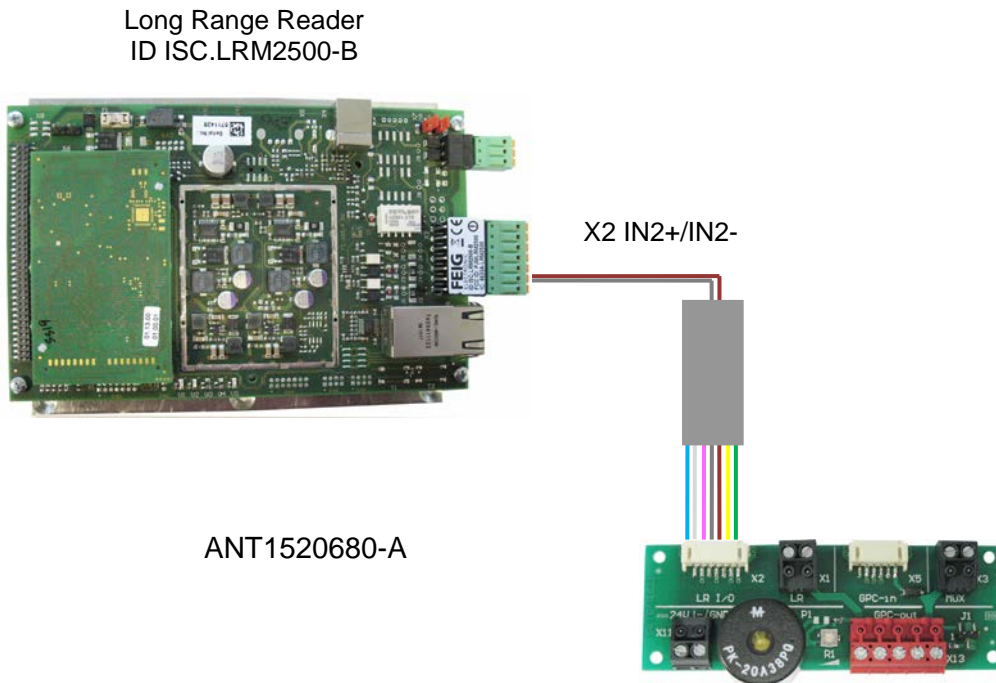

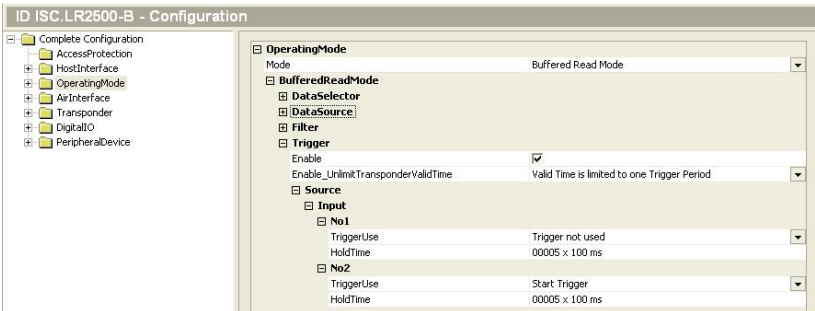

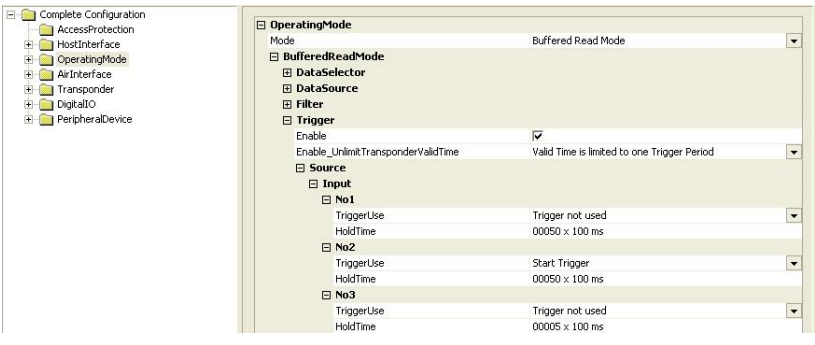

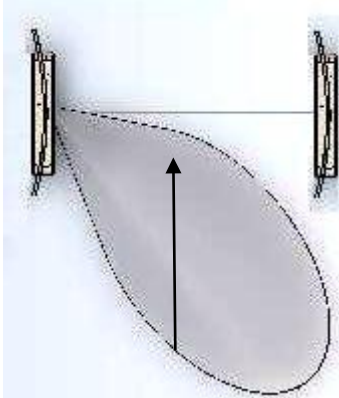



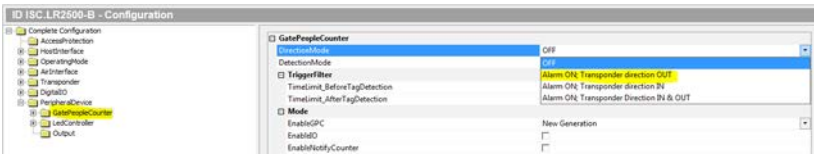
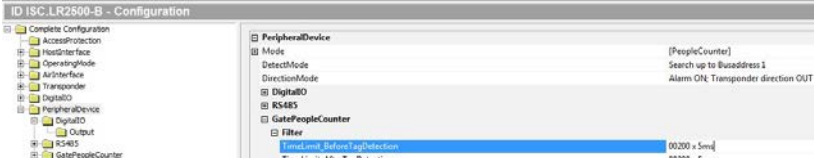

Fig. 30

Step	Action	Note
1	Select „Configuration“	
2	<p>Operating Mode</p> <p>Select -Buffered Read Mode or -Notification Mode</p>	
3	Confirm with „Apply“	
4	<p>Operating Mode</p> <p>Set -Trigger enable -Source Input No 2-Trigger TriggerUse set to - Start Trigger - Hold Time e.g. 20x100ms =2sec.</p>	
5	Confirm with „Apply“	
6	Multiplexer stops switching of antennas. All Output LED's at Outputs of Multiplexer are switched off.	
7	Walk through the gate. Multiplexer/Gate will be switch on for the set time.	

7.2.5 Using the direction detection of transponder with the People Counter

In combination with the People Counter a direction detection of the transponders could be performed in that way, that only transponder will cause an alarm which move in the configured direction through the gate. This should reduce false alarms. It is possible that cross traffic in front of the antenna could still cause false alarms, if a valid transponder moves in the set direction.

It is mandatory that the trigger cable described in [7.2.4 Using the trigger function of the Gate People Counter](#) is connected to Input 2 of the reader and X4/TRG of the terminal board, otherwise the direction mode will not work!

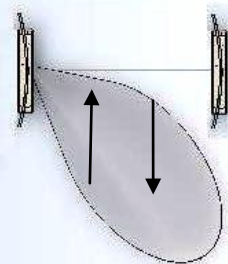
Step	Action	Note
1	Select „Configuration“	
2	<p>Select Peripheral Devices – Gate People Counter</p> <p>Set Direction Mode to the needed alarm direction.</p> <p>Select Peripheral Devices - Filter</p> <p>Set Time Limit before and after Tag Detection.</p> <p>e.g. 200x5ms =1000ms</p> <p>Time should be not to short or to long !</p>	 
3	Confirm with „Apply“	
7	Walk through the gate with a valid transponder and check the alarm direction.	

At multiple gates with more than two antennas, it is mandatory that the correct number order of the connected antennas, alarm LED and people counter with radar module must be observed. Setup, Connecting and Configuration hints could be found in the Application Note N71052-xe-ID-B.pdf

7.2.6 Detection Area of Direction Mode

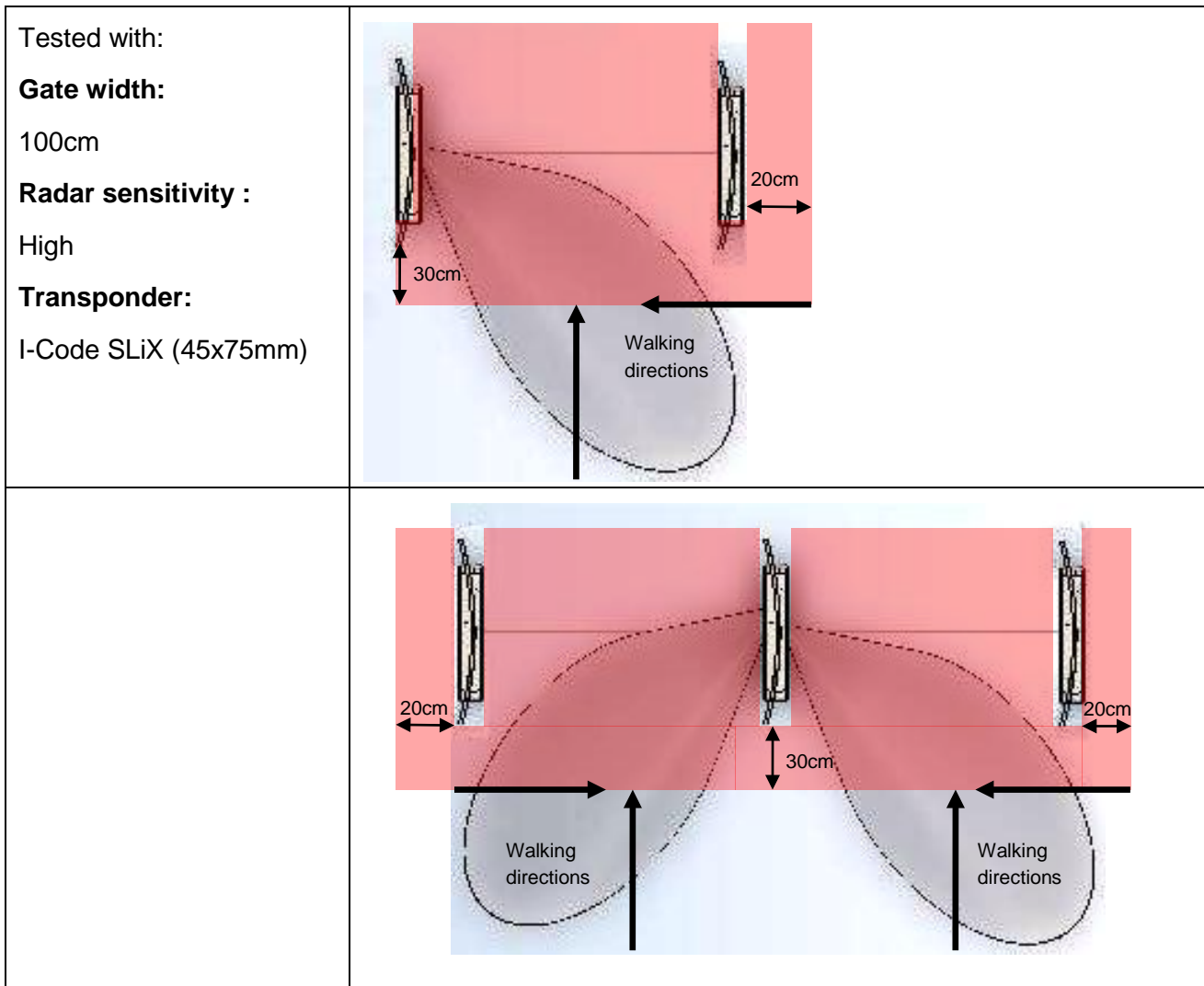

Fig. 31

8 Configure the reader in accordance with national RF regulations

Configuration of the RFID readers and the maximum transmitting power of the antennas are affected mainly by the country-specific RF regulations. For the entire EU the limits are set forth in the R&TTE Directive and EN 300 330. In North America this is regulated by FCC Part 15 (USA) and by the RSS-210 (Canada).

The ID ISC.ANT1710/690 Crystal Gate antenna with the ID ISC.LRM2500 Reader, when used as intended, complies with the basic requirements of Article 3 and the other relevant clauses of the R&TTE Directive 1999/5/EG of March 1999. This means that operation in the 27 EU countries and the EFTA countries (EU countries plus Switzerland, Norway and Iceland) is possible with a maximum field strength of 42 dB μ A/m at 10 m distance.

RF approval (at a maximum field strength of 84 dB μ V/m at 30 m) for the ID ISC.ANT1710/690 Crystal Gate antenna with ID ISC.LRM2500 Reader has been granted in accordance with FCC Part 15 for the USA and the RSS-210 for Canada

RF approval in accordance with EN 300 330 is still possible in all 46 CEPT countries.

The CEPT countries are:

Albania (ALB), Andorra (AND), Austria (AUT), Azerbaijan (AZE), Belarus (BLR), Belgium (BEL), Bulgaria (BUL), Bosnia and Herzegovina (BIH), Croatia (HRV), Cyprus (CYP), Czech Republic (CZE), Denmark (DNK), Estonia (EST), Finland (FIN), France (F), Germany (D), Greece (GRC), Hungary (HNG), Iceland (ISL), Ireland (IRL), Italy (I), Latvia (LVA), Liechtenstein (LIE), Lithuania (LTU), Luxembourg (LUX), Malta (MLT), Former Yugoslav Republic of Macedonia (MKD), Moldova (MDA), Monaco (MCO), Netherlands (HOL), Norway (NOR), Poland (POL), Portugal (POR), Romania (ROU), Russian Federation (RUS), San Marino (SMR), Slovak Republic (SVK), Slovenia (SVN), Spain (E), Sweden (S), Switzerland (SUI), Turkey (TUR), Ukraine (UKR), United Kingdom (G), Vatican City (CVA) and Yugoslavia.

The following restrictions are in effect (as of: August 2011):

1. Outside the EU and EFTA countries RF approval must in all cases be applied for. The existing measuring protocols in accordance with EN 300 330 are generally sufficient.

When placing the antennas in service, the systems integrator must ensure that the prescribed mounting instructions are followed, the necessary Reader settings are made and permissible limits according to the national regulations are not exceeded.

The reader needs to be configured as follows depending on the installation location:

Parameter	USA / Canada / Europe (42dBuA/m)
Air Interface	
RF-Power:	maximum 8 W
RF Modulation:	15%
Transponder	
RF Modulation	10%
RF Data coding ISO-MODE:	Fast (1/4) or Normal (1/256)
No of Timeslots	1 or 16 Timeslots

9 Technical Data

9.1 Antenna ID ISC.ANT1710/690 Crystal Gate Type A and B

Mechanical Data

- **Housing** **UV stabilized ABS and Acrylic**
- **Dimensions (W x H x D)**
 - **Antenna** **682 mm x 1710 mm x 72 mm ± 3 mm**
 - **Packing** **870 mm x 1800 mm x 180 mm ± 10 mm**
- **Weight**
 - **ID ISC.ANT1710/690 Type A** **Approx. 20 kg without / 26 kg with packing**
 - **ID ISC.ANT1710/690 Type B** **Approx. 18 kg without / 24 kg with packing**
- **Enclosure rating** **IP 41**
- **Color** **Antenna frame: clear transparent
Antenna base: signal white RAL 9003**
- **Mounting**
 - **No. of attaching points** **2**
 - **Recommended anchors** **Ø 10 mm**
 - **Recommended minimum load capacity of the floor fastener** **5000 N / anchor**
- **Maximum horizontal load on the top edge of the antenna** **200 N***

Electrical Data****

- **Supply Voltage** 24 V \pm 15 %
Noise Ripple : max. 150 mV
- **Power Consumption** max. 32 VA
- **Operating Frequency** 13,56 MHz
- **Maximum transmitting power per antenna** 8 W
- **Permissible overall transmitting power per antenna gate**
 - EU-territory (per EN 300 330) 8.0 W
 - USA (per. FCC Part 15) 8.0 W
 - Canada (per. RSS 210) 8.0 W
- **Outputs**
 - 1 Optocoupler 24 V \pm / 30 mA
 - 1 Optocoupler Reader Synchronization
 - 1 Relay (1 x NO) 24 V \pm / 1 A for Alarm Kit
- **Inputs**
 - 1 Optocoupler Max. 24 V \pm / 20 mA
 - 1 Optocoupler Reader Synchronisation
- **Interfaces**
 - USB
 - Ethernet (TCP/IP)
- **Protocol Modes**
 - FEIG ISO HOST
 - BRM (Data Filtering and Data Buffering)
 - Scan Mode (USB)
 - Notification Mode (TCP/IP)
- **Supported Transponders**
 - ISO 15693, ISO 18000-3-A Mode 1,
(EM HF ISO Chips, Fujitsu HF ISO Chips,
KSW Sensor Chips, Infineon my-d, NXP I-
Code , STM ISO Chips, TI Tag-it)
NXP I-Code 1
- **Ranges / pass-through width in gate with multiplexer**
 - One tag orientation up to 130 cm**
 - All tag orientations up to 110 cm***
- **Antenna connection** 1 x SMA plug (50 Ω)
- **Antenna connector cable**
 - Type B RG58, 50 Ω , approx. 8,55 m long

Ambient Conditions

- **Temperature range**
 - Operating –25 °C to +50 °C
 - Storage –25 °C to +70 °C

Applicable Standards

- **RF approval**
 - Europe EN 300 330
 - USA FCC Part 15
 - Canada RSS-210
- **EMC** EN 301 489
- **Safety**
 - Low Voltage Directive EN 60950-1
 - Human Exposure EN 50364
- **Product testing** ISO 18046-4 / VDI-4478-1

* Persistent deformation after load release approx. 4 cm.

** Qty. 2 ID ISC.ANT1710/690-A/-B Crystal Gate antennas, antenna spacing (antenna center), same flow direction, Tag 46 mm x 75 mm ISO15693, sensitivity / minimum field strength $H_{\min}=40$ mA/m rms, transmitting power 8 W, tag orientation parallel to antenna for horizontal movement through the antenna. The maximum antenna distance also depending of the strength of the Transponder answer signal!

*** Qty. 2 ID ISC.ANT1710/690-A/-B Crystal Gate antennas, antenna spacing (antenna center), Tag 46 mm x 75 mm ISO 15693, sensitivity / minimum field strength $H_{\min}=40$ mA/m rms, transmitting power 8 W, aligned in all 3 dimensions for horizontal movement through the antenna. The maximum antenna distance also depending of the strength of the Transponder answer signal!

9.2 People Counter ID ISC.ANT.GPC and ID ISC.ANT.GPC-E2

Mechanical Data

• Housing	Printed Boards
• Board Dimensions (B x H x T)	
– People Counter Board	100 mm x 40 mm x 16 mm ± 1 mm
– Radar Sensor Board	60 mm x 30mm x 25 mm ± 1 mm
• Weight	
– ID ISC.ANT.GPC	ca. 200 g / 250 g (0.55 lb) with packing
– ID ISC.ANT.GPC-E2	ca. 50 g / 100 g (0.22 lb) with packing
• Mounting	
– No. of attaching points	People Counter: 4 / Radar Sensor: 2

Electrical Data

• Supply Voltage	• 24 V \pm 15 %
• Power Consumption	• max. 2 VA
• Operating Frequency	• 24,125 GHz
• RF-transmitting power	• 16 dBm (e.i.r.p.)
• Temperature range	
– Operation	–25 °C to +55 °C
– Storage	–25 °C to +85 °C

9.3 Approvals

As per Section [8 Configure the reader in accordance with national RF regulations](#)

9.3.1 Europe (CE)

9.3.1.1 Antenne ID ISC.ANT1710/690 Crystal Gate

This RF equipment is in compliance with the essential requirements and other relevant provisions of Directive 1999/5/EC dated March 99.



Equipment Classification according to ETSI EN 300 330 and ETSI EN 301 489: Class 2

The technical data of the ID ISC.LRM2500-B Reader built into the ID ISC.ANT1710/690 Crystal Gate -A antenna can be found in the Installation Manual which is included with the device.

9.3.1.2 People Counter ID ISC.ANT.GPC

This RF equipment is in compliance with the essential requirements and other relevant provisions of Directive 1999/5/EC dated March 99.



Equipment Classification according to ETSI EN 300 330 and ETSI EN 301 489: Class 2

9.3.2 USA (FCC) and Canada (IC)

9.3.2.1 Antenna ID ISC.ANT1710/690 Crystal Gate

Product name:	ID ISC.ANT1710/690 Crystal Gate
Antenna name:	ID ISC.ANT1710/690 Crystal Gate Type A
Reader name:	ID ISC.LRM2500-B
FCC ID: IC:	PJMLRM2500 6633A-LRM2500
<p>Notice for USA and Canada</p> 	<p>This device complies with Part 15 of the FCC Rules and with RSS-210 of Industry Canada.</p> <p>Operation is subject to the following two conditions.</p> <p>(1) this device may not cause harmful interference, and</p> <p>(2) this device must accept any interference received, including interference that may cause undesired operation.</p> <p>Unauthorized modifications may void the authority granted under Federal communications Commission Rules permitting the operation of this device.</p> <p>This equipment has been tested and found to comply with the limits for a Class A digital device, pursuant to Part 15 of the FCC Rules. These limits are designed to provide reasonable protection against harmful interference when the equipment is operated in a commercial environment. This equipment generates, uses, and can radiate radio frequency energy and, if not installed and used in accordance with the instruction manual, may cause harmful interference to radio communications. Operation of this equipment in a residential area is likely to cause harmful interference in which case the user will be required to correct the interference at his own expense.</p> <p>Le présent appareil est conforme aux CNR d'Industrie Canada applicables aux appareils radio exempts de licence. L'exploitation est autorisée aux deux conditions suivantes :</p> <p>(1) l'appareil ne doit pas produire de brouillage, et</p> <p>(2) l'utilisateur de l'appareil doit accepter tout brouillage radioélectrique subi, même si le brouillage est susceptible d'en compromettre le fonctionnement.</p>

Further information and technical data of the ID ISC.LRM2500-BB Reader built into the ID ISC.ANT1710/690 Crystal Gate antenna can be found in the Installation Manual of the reader which is content of the delivery.

9.3.2.2 People Counter ID ISC.ANT.GPC

FCC ID: IC:	UXS-IPS154US 6633A-GPC
Notice for Canada	<p>Operation is subject to the following two conditions:</p> <p>(1) this device may not cause interference, and (2) this device must accept any interference, including interference that may cause undesired operation of the device. Usually this is followed by the following RSS caution:</p> <p>Any changes or modifications not expressly approved by the party responsible for compliance could void the user's authority to operate this equipment.</p> <p>Le présent appareil est conforme aux CNR d'Industrie Canada applicables aux appareils radio exempts de licence. L'exploitation est autorisée aux deux conditions suivantes :</p> <p>(1) l'appareil ne doit pas produire de brouillage, et (2) l'utilisateur de l'appareil doit accepter tout brouillage radioélectrique subi, même si le brouillage est susceptible d'en compromettre le fonctionnement.</p>

9.3.3 USA and Canada (UL)

<p>UL US LISTED Accessory I.T.E E304312</p> <p>FEIG ELECTRONIC ID ISC.ANT1710/690-A Crystal Gate Input 24V max. 1.5A This unit has to be supplied by a listed NEC Class 2/LPS Power Supply only. For use with connections to Listed ITE equipment and accessories only MAC: 12:34:56:78:90:AB DevID: 1234567890AB</p> <p style="writing-mode: vertical-rl; transform: rotate(180deg);">Serial No.: 1234567</p>	<p>UL US LISTED Accessory I.T.E E304312</p> <p>FEIG ELECTRONIC ID ISC.ANT1710/690-B Crystal Gate For use with connections to antenna ID ISC.ANT1710/690 Crystal Gate Standard Type-A only.</p> <p>Serial No.:1234567</p>
---	--

The following picture indicates the label position:



10 Annex A

10.1 Terminal assignment “Terminal Board”

Terminal	Acronym	Description
X1 / LR		24V DC Reader
X1 / Pin 1	24V	+24 V DC Reader
X1 / Pin 2	GND	GND Reader
X2 / LR I/O		24V DC Input/Output , RS485
X2 / Pin 1		RS485 A-
X2 / Pin 2		RS485 B+
X2 / Pin 3		GND
X2 / Pin 4		TRG Trigger People Counter
X2 / Pin 5		GND
X2 / Pin 6		Buzzer
X2 / Pin 7		Shield
X3 / MUX		24V DC Multiplexer
X3 / Pin 1	24V	+24 V DC Multiplexer
X3 / Pin 2	GND	GND Multiplexer
X5 / GPC-in		Connection Cable to People Counter or LED
X5 / Pin 1		+24V DC
X5 / Pin 2		GND People Counter or LED
X5 / Pin 3		RS485 A-
X5 / Pin 4		RS485B+
X5 / Pin 5		TRG Trigger People Counter
X5 / Pin 6		Shield
X11		24V DC Power Supply
X11 / Pin 1	24V	Power Supply +24 V DC
X11 / Pin 2	- / GND	Ground – Power Supply
X13 / GPC-out		Connection Cable to next antenna
X13 / Pin 1	24V	+24 V DC
X13 / Pin 2	GND	GND
X13 / Pin 3	TRG	TRG Trigger People Counter
X13 / Pin 4	A-	RS485 A-
X13 / Pin 5	B+	RS485 B+

Table 10: Pin-Configuration X1-X13 Terminal Board

10.2 Internal wiring

Terminal	Acronym	Description
X1 / LR		24V DC Reader
X1 / Pin 1		X13 +24 V DC Reader (red)
X1 / Pin 2	GND	X13 GND Reader (black)
X2 / LR/I/O		24V DC Input/Output, RS485
X2 / Pin 1		Reader LR2500 X3 Pin RS485 B+ (green)
X2 / Pin 2		Reader LR2500 X3 Pin RS485 A- (yellow)
X2 / Pin 3		Reader LR2500 X2 Pin IN2- (brown)
X2 / Pin 4		Reader LR2500 X2 Pin IN2+ (grey)
X2 / Pin 5		Reader LR2500 X2 Pin Out2-E (pink)
X2 / Pin 6		Reader LR2500 X2 Pin Out2-C (white)
X2 / Pin 7		Reader LR2500 X2 GND (black)
X3 / MUX		24V DC Multiplexer
X3 / Pin 1		X1 +24 V DC Multiplexer (red)
X3 / Pin 2	GND	X1 GND Multiplexer (black)
X5 / GPC-in		Connection Cable to People Counter /LED
X5 / Pin 1		GPC X1 Pin 1 +24 V DC GPC/LED (white)
X5 / Pin 2		GPC X1 Pin 2 GND GPC/LED (brown)
X5 / Pin 3		GPC X1 Pin 3 RS485-A (green)
X5 / Pin 4		GPC X1 Pin 4 RS485+B (yellow)
X5 / Pin 5		GPC X1 Pin 5 TRG Trigger People Counter (grey)
X5 / Pin 6		GPC X1 Pin 6 Shield (blue)