



# ID ISC.LRU1002 (EU: 4127.001.00; FCC: 4128.001.00)

UHF Long Range Reader



## Note

© Copyright 2017-2018 by  
FEIG ELECTRONIC GmbH  
Lange Strasse 4  
D-35781 Weilburg  
Tel.: +49 6471 3109-0  
<http://www.feig.de>

With the edition of this document, all previous editions become void. Indications made in this manual may be changed without previous notice.

Copying of this document, and giving it to others and the use or communication of the contents thereof are forbidden without express authority. Offenders are liable to the payment of damages. All rights are reserved in the event of the grant of a patent or the registration of a utility model or design.

Composition of the information in this document has been done to the best of our knowledge. FEIG ELECTRONIC GmbH does not guarantee the correctness and completeness of the details given in this manual and may not be held liable for damages ensuing from incorrect or incomplete information. Since, despite all our efforts, errors may not be completely avoided, we are always grateful for your useful tips.

The instructions given in this manual are based on advantageous boundary conditions. FEIG ELECTRONIC GmbH does not give any guarantee promise for perfect function in cross environments and does not give any guaranty for the functionality of the complete system which incorporates the subject of this document.

FEIG ELECTRONIC call explicit attention that devices which are subject of this document are not designed with components and testing methods for a level of reliability suitable for use in or in connection with surgical implants or as critical components in any life support systems whose failure to perform can reasonably be expected to cause significant injury to a human. To avoid damage, injury, or death, the user or application designer must take reasonably prudent steps to protect against system failures.

FEIG ELECTRONIC GmbH assumes no responsibility for the use of any information contained in this document and makes no representation that they free of patent infringement. FEIG ELECTRONIC GmbH does not convey any license under its patent rights nor the rights of others.

---

## Contents

---

<b>1. Safety Instructions / Warning - Read before start-up !</b>	<b>5</b>
<b>2. Performance Features of Reader Family ID ISC.LRU1002</b>	<b>6</b>
2.1. Performance features.....	6
2.2. Available reader types.....	6
<b>3. Installation</b>	<b>7</b>
<b>4. Terminals</b>	<b>8</b>
4.1. Antenna Connection .....	9
4.2. Power Supply.....	10
4.2.1. Power Supply via connection X2.....	10
4.3. Interfaces .....	11
4.3.1. Ethernet Interface on connector X1.....	11
4.3.2. USB Mini Interface on connector X3 .....	11
4.3.2.1. <i>USB-Stick Service-Functions</i> .....	12
4.3.2.2. <i>Reading of Log and Service Data</i> .....	12
4.3.2.3. <i>Storing the reader configuration on a USB flash drive</i> .....	13
4.3.2.4. <i>Copy the configuration onto the reader (Config-Cloning)</i> .....	13
4.3.3. RS232 Interface on connector X4 .....	14
4.3.4. Data-Clock Interface on connector X4.....	15
4.4. Inputs and Outputs on connector X4 .....	17
4.4.1. 24 V DC voltage on connector X4 .....	17
4.4.2. Digital Inputs on connector X4 .....	18
4.4.3. Digital outputs on connector X4 .....	19
4.4.4. Relay output on connector X4 .....	20
<b>5. Operating and Display Elements</b>	<b>21</b>
5.1. Status LED .....	21
5.2. Reset Push Button T1 .....	22
5.3. Reader Power Adjustment .....	23

---

5.3.1. EU reader according to EN302 208.....	23
5.3.2. FCC-Reader according to FCC 47 Part 15.....	24

---

<b>6. Technical Data</b>	<b>25</b>
--------------------------	-----------

---

<b>7. Radio Approvals</b>	<b>28</b>
---------------------------	-----------

---

<b>7.1. Europe (CE).....</b>	<b>28</b>
------------------------------	-----------

<b>7.2. USA (FCC) and Canada (IC) .....</b>	<b>29</b>
---	-----------

7.2.1. USA (FCC) and Canada (IC) warning notices .....	29
--	----

7.2.2. Label Information .....	30
--------------------------------	----

7.2.3. Installation with FCC / IC Approval.....	30
---	----

7.2.4. USA (FCC) and Canada (IC) approved antennas .....	30
--	----

---

<b>ANNEX A - Accessories</b>	<b>31</b>
------------------------------	-----------

---

---

**1. Safety Instructions / Warning - Read before start-up !**

---

- The device may only be used for the intended purpose designed by for the manufacturer.
- The operation manual should be conveniently kept available at all times for each user.
- Unauthorized changes and the use of spare parts and additional devices which have not been sold or recommended by the manufacturer may cause fire, electric shocks or injuries. Such unauthorized measures shall exclude any liability by the manufacturer.
- The liability-prescriptions of the manufacturer in the issue valid at the time of purchase are valid for the device. The manufacturer shall not be held legally responsible for inaccuracies, errors, or omissions in the manual or automatically set parameters for a device or for an incorrect application of a device.
- Repairs may only be executed by the manufacturer.
- Installation, operation, and maintenance procedures should only be carried out by qualified personnel.
- Use of the device and its installation must be in accordance with national legal requirements and local electrical codes .
- When working on devices the valid safety regulations must be observed.
- This device is not suitable to be used in places where children are present. Prevent children access to the device.
- Equipment is intended for use only in restricted access area.
- Special advice for carriers of cardiac pacemakers:

Although this device doesn't exceed the valid limits for electromagnetic fields you should keep a minimum distance of 25 cm between the device and your cardiac pacemaker and not stay in an immediate proximity of the device respective the antenna for some time.

---

## 2. Performance Features of Reader Family ID ISC.LRU1002

---

### 2.1. Performance features

---

The reader has been developed for reading passive data carriers, so-called „Smart Labels“, using an operating frequency in the UHF range. The output power is configurable in the range between 100 mW and 2 W. This allows read ranges of up to 12 m.

---

### 2.2. Available reader types

---

The following readers are available:

Table 1: Available Reader Types

Order Number	Reader type	Description
4127.001.00	ID ISC.LRU1002-EU	Device version for Europe
4128.001.00	ID ISC.LRU1002-FCC	Device version for North America
4861.000.00	ID ISC.LRU1002-MA	Device version for Morocco

### 3. Installation

The Reader is designed for wall-mount, including outdoors. Outdoors the reader should be mounted like shown in the picture below to ensure the watertightness of the device.

Holes for mounting on a wall with countersunk head screws are provided in the housing. The maximum head screw diameter should not exceed 8,0 mm. The thread diameter is 5,3 mm (M5 screws). The screws must have a minimum length of 45 mm depending on the installation situation. It is not necessary to open the reader housing for installation.

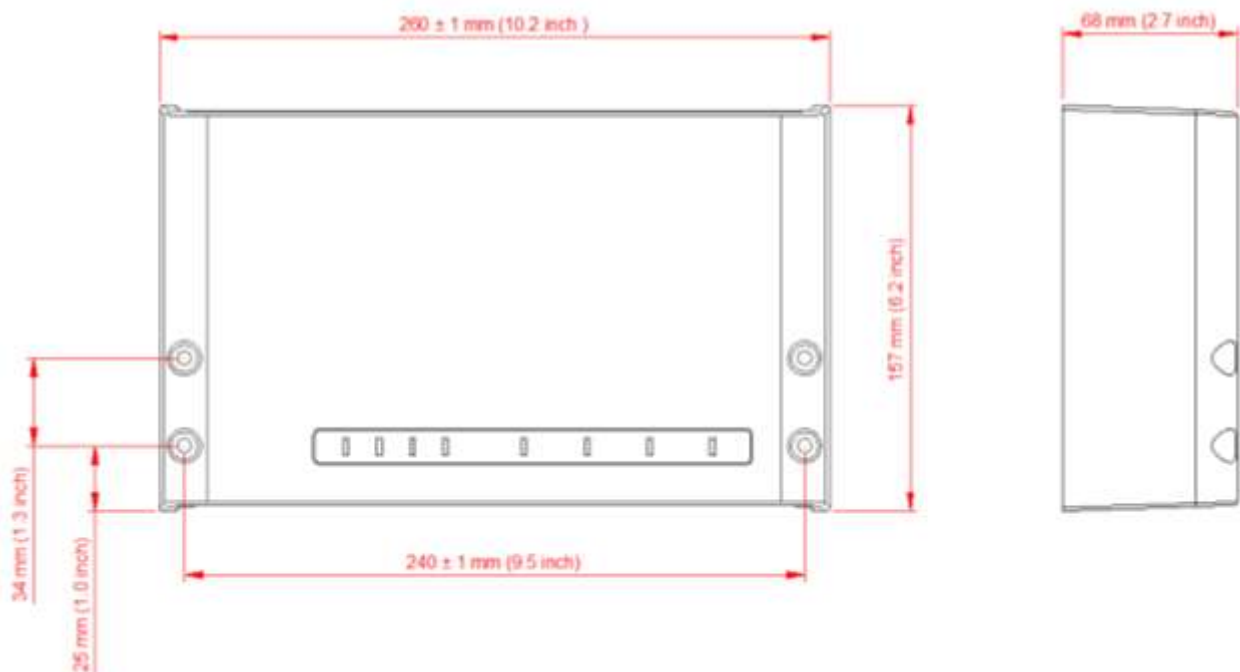

Figure 1: Installation Drawing

## 4. Terminals

On the lower side of the reader housing different connectors are positioned. Figure 2 shows the arrangement of the connectors and Table 2: Connection terminals gives an overview on the available interfaces and signals. Table 3: Push button function shows the available push buttons.

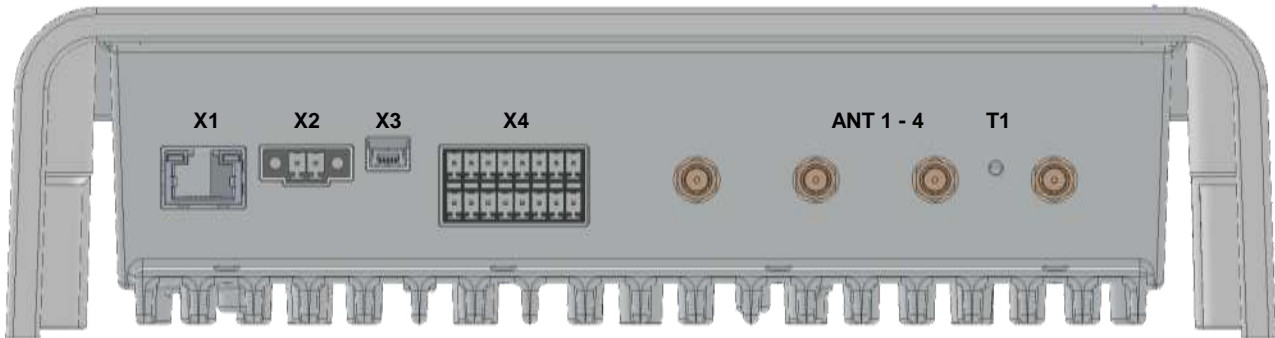

Figure 2: Connection Overview

Table 2: Connection terminals

Connector	Description
ANT 1-4	<a href="#">Connection of the external antennas (Impedance 50Ω)</a>
X1	<a href="#">10/100Tbase network connection with RJ-45</a>
X2	<a href="#">Power supply 24VDC ± 20%</a>
X3	<a href="#">USB Mini Interface</a>
X4	<a href="#">Digital input, digital output, relay output and RS232 interface</a>

Table 3: Push button function

Push button	Description
T1	<a href="#">Internal push button for complete configuration reset</a>



## 4.1. Antenna Connection

The external SMA antenna connectors are positioned on the lower side of the reader.

The maximum tightening torque for the SMA sockets is 0.45 Nm (4.0 lbf in).

For supplying a DC voltage to external components e.g. the UHF antenna multiplexer ID ISC.ANT.UMUX, it is possible to enable a supply voltage (24 V DC / max. 500mA) on the antenna cable. This need to be configured in the reader.

Table 4: External antenna connection

Terminal	Description
ANT 1 - 4	Connection for external antennas (input impedance 50Ω)

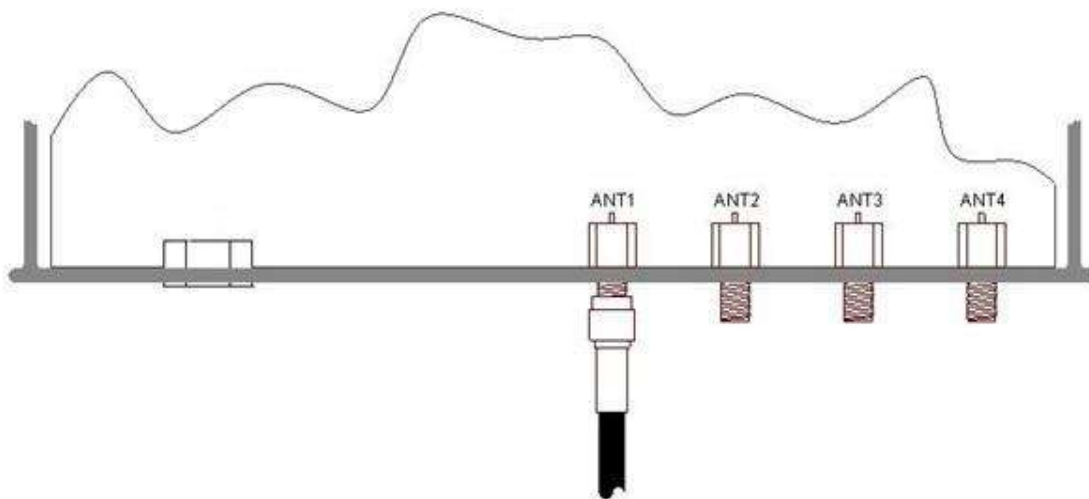

Figure 3: External antenna connection ANT1-4

**CAUTION:**

***Exceeding the tightening torque will destroy the plug.***

***The activation of the DC voltage on the antenna cable can damage the antennas from other manufacturers. It is recommend to use high resistance UHF antennas. For any further questions please contact the technical support.***

## 4.2. Power Supply

### 4.2.1. Power Supply via connection X2

The supply voltage of 24 V DC has to be connected to Terminal X2.

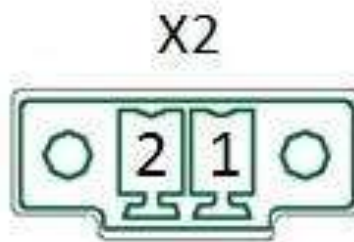

Figure 4: Connector X2 Pin assignment for power supply

Table 5: Pin assignment for power supply

Terminal	Abbreviation	Description
X2 / Pin 1	VDC	Supply voltage 24 V DC $\pm 20\%$
X2 / Pin 2	GND	Ground – supply voltage

#### **CAUTION:**

**The reader has to be supplied by a limited power supply according EN 62368-1 Chapter Q.1, or with a NEC Class 2/LPS certified power supply.**

**Each reader has to be supplied by a separate external power supply.**

**Reversing the polarity of the supply voltage on X2 may destroy the device.**

**External wiring for the power supply must fulfil the following norms/validation procedure:**

Conductor Cross-section	Validation procedure
from 0,5 mm <sup>2</sup> or bigger	IEC 60332-1-2 and IEC 60332-1-3
smaller than 0,5 mm <sup>2</sup>	IEC 60332-2-1 and IEC 60332-2-2

---

## 4.3. Interfaces

---



---

### 4.3.1. Ethernet Interface on connector X1

---

The Reader has an integrated 10 / 100 base-T network port for an RJ-45. Connection is made on X1 and has an automatic "Crossover Detection" according to the 100BASE-T Standard.

With structured cabling STP CAT 5 cables should be used. This ensures a reliable operation at 10 Mbps or 100 Mbps.

The prerequisite for using TCP/IP protocol is that each device has a unique IP address on the network. All Readers have a factory set IP address.

Table 6: Standard factory configuration of the Ethernet connection

Network	Address
IP-Adresse	192.168.10.10
Subnet-Mask	255.255.0.0
Port	10001
DHCP	OFF

**NOTE:**

***The reader is equipped with a DHCP ready Ethernet Interface.***

---

### 4.3.2. USB Mini Interface on connector X3

---

The reader is equipped with a USB on-the-go interface. This can either be used to connect the reader to a host system or by means of a special on-the-go adaptor for connection of a USB memory stick to the reader. In both cases the connection is carried out via terminal X3. The pinout is standardized.



Figure 5: USB-Interface for host communication

A standard shielded USB-cable can be used for connection of the reader to a host system. The data rate is reduced to 12 Mbit (USB full speed).

**NOTE:**

***The length of the USB-cable can have a max. of 5m (200 inch). It is not allowed to use longer cables.***

---

#### 4.3.2.1. USB-Stick Service-Functions

---

Via an optionally available USB On-The-Go adapter cable, the interface can be converted to a USB host interface. The adapter cable allows the connection of a USB memory stick to the reader. By means of the USB stick various service functions can be carried out e.g. the read-out of log and service files and uploading of a configuration file.



Figure 6: USB On-The-Go adapter cable

---

#### 4.3.2.2. Reading of Log and Service Data

---

After plug-in of the USB flash drive on the running ID ISC.LRU1002 the reader will generate a subdirectory on the root directory of the USB flash drive. The name of the subdirectory is equal to the Device-ID of the connected reader (see type plate of the reader). Within this subdirectory the reader stores device information like firmware version and IP-address in the file INFO.LOG. If there exist already such a file for the same reader the file will be updated with the information and the current date and time.

Additionally the files ACTION.LOG and SERVICE.LOG will be generated and stored for service purposes on the USB flash drive. The meaning of the CONFIG.INI will be described in the next chapter.

After plug-in of the USB flash drive the green and red status LED of the ID ISC.LRU1002 are permanently lit as long as the USB flash drive is actively used by the reader. When the USB actions are completed successfully, the red LED is switched off and the green LED starts flashing. The USB flash drive can be removed after the red LED is switched off. If the USB actions failed the red status LED starts flashing until the USB flash drive is removed.

**NOTE:**

- **After plug-in of the USB flash drive the status LEDs of the reader shall be monitored.**
- **The USB flash drive shall only be removed from the reader if the USB actions have been completed and the flash drive is not in use anymore.**
- **The USB On-The-Go adapter cable may only be used in conjunction with a USB memory stick. When used for a PC connection, the reader can be destroyed!**

---

#### 4.3.2.3. Storing the reader configuration on a USB flash drive

---

While connecting the USB flash drive on a running reader, the reader will store the configuration as a editable and readable CSV-file (CONFIG.INI) on the USB flash drive. This file will be stored in the main directory for easy coping of the configuration ([4.3.2.4. Copy the configuration onto the reader \(Config-Cloning\)](#)). Additionally the same file will be stored in the subdirectory named after the according Device-ID (see type plate of the reader). Thereby it is possible to store several configuration files on the same USB flash drive.

All not locked configuration pages (CFG pages) including the interface parameter will be copied from the reader onto the USB flash drive. Password protected configuration pages will not be copied.

After plug-in of the USB flash drive the green and red status LED are permanently lit as long as the USB flash drive is actively used by the reader. When the USB actions are completed successfully, the red LED is switched off and the green LED starts flashing. The USB flash drive can be removed after the red LED is switched off. If the USB actions failed the red status LED starts flashing until the USB flash drive is removed.

**Note:**

***If there exists already a configuration file CONFIG.INI on the main directory of the USB flash drive, the old file will be overwritten by the new configuration file.***

***Configuration pages which are protected by a password (see CFG0) will be not stored on the USB flash drive. No error message will appear.***

***After connecting the USB flash drive on the reader USB port, the reader LEDs should be observed.***

***The USB flash drive shall only be removed from the reader if the USB actions have been completed and the flash drive is not in use anymore.***

---

#### 4.3.2.4. Copy the configuration onto the reader (Config-Cloning)

---

In order to connecting the USB flash drive on the reader USB port and copy the configuration from the USB flash drive onto the reader, it is necessary to switch off the reader before plug-in the USB flash drive. After switching on the reader the boot process will look for a connected USB flash drive and will copy the existing configuration file onto the reader.

It must be ensured that no configuration page (CFG page) is locked inside the reader. If configuration pages are locked the configuration file will not be copied onto the reader. If single configuration parameters in the configuration file were out of range and invalid the configuration file will not be copied onto the reader as well.

After the copy process has been finished the green LED will start flashing and the red LED goes off. After the red LED goes off the USB flash drive can be disconnected. If the USB actions failed the red status LED starts flashing until the USB flash drive is removed.

**Note:**

***Connecting an USB flash drive on a running reader will always overwrite an existing configuration file in the main directory on the USB flash drive (see [4.3.2.3. Storing the reader configuration on a USB flash drive](#)).***

4.3.3. RS232 Interface on connector X4

The RS232 interface is connected on X4. The transmission parameters can be configured by means of software protocol.

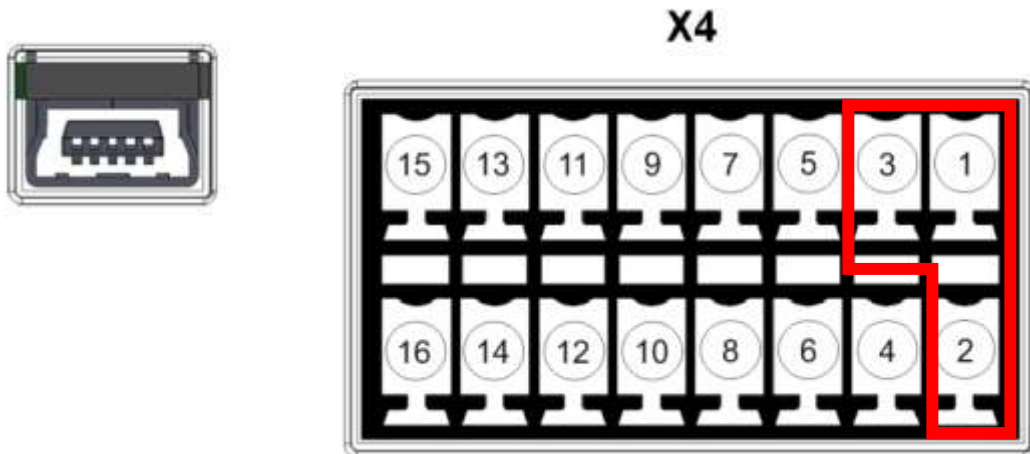

Figure 7: RS232 interface pin-outs on X4

Table 7: Pin Assignment RS232 Interface

Pin Number at Connector X4	Pin Assignment
1	RS232 – RxD
2	RS232 – TxD
3	GND

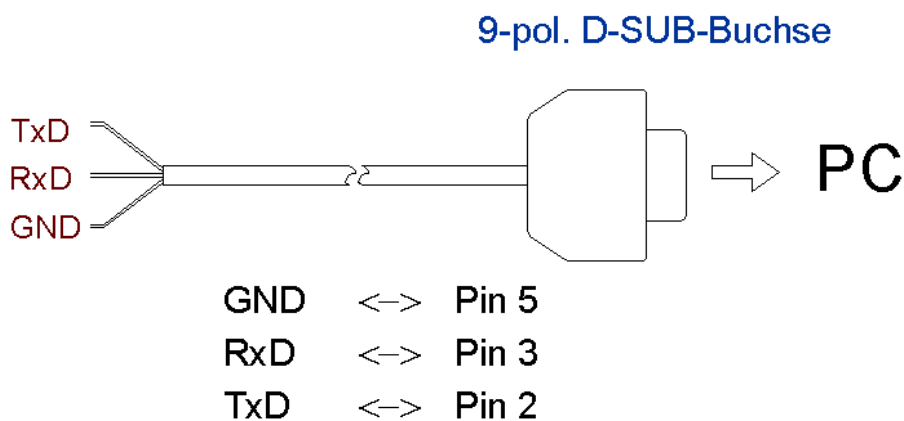

Figure 8: Wiring example for connecting the RS232 interface to a 9 pin D-SUB plug

#### 4.3.4. Data-Clock Interface on connector X4

The connection of the data-clock interface takes place via the digital Outputs OUT1 and OUT2 at connector X4. The wire for the clock (Data-0) needs to be connected to connector OUT1-E, the wire for the data (Data-1) needs to be connected to connector OUT2-E.

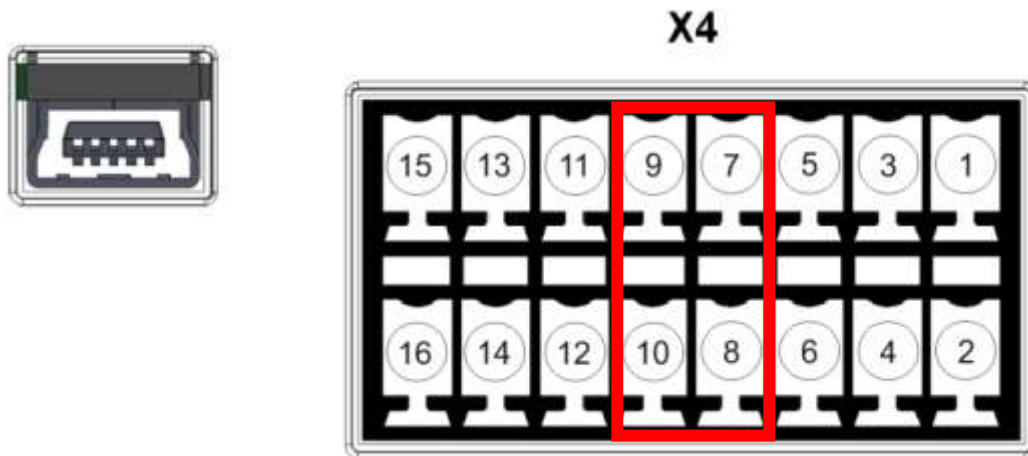

Figure 9: Data-Clock Interface on connector X4

Table 8: Pin Assignment Data/Clock Interface

Pin Number at Connector X4	Pin Assignment
7	Clock / Data-0
8	Vcc
9	Data / Data-1
10	Vcc

**NOTE:**

*The data-clock interface is only available in Scan-Mode.*

*The data-clock interface cannot be used to configure the reader.*

*The digital outputs OUT1 and OUT2 are not available, if the data-clock interface is activated.*

*The data as well as the clock need to be supplied with an external voltage. The output is designed for max. 24 V DC / 20 mA.*

For access control application it is possible to connect the reader parallel with two inputs of a Wiegand controller. By that it is possible to control two traffic lanes (e.g. Entrance and Exit). Please read the application note N61011-xe-ID-B for more details.

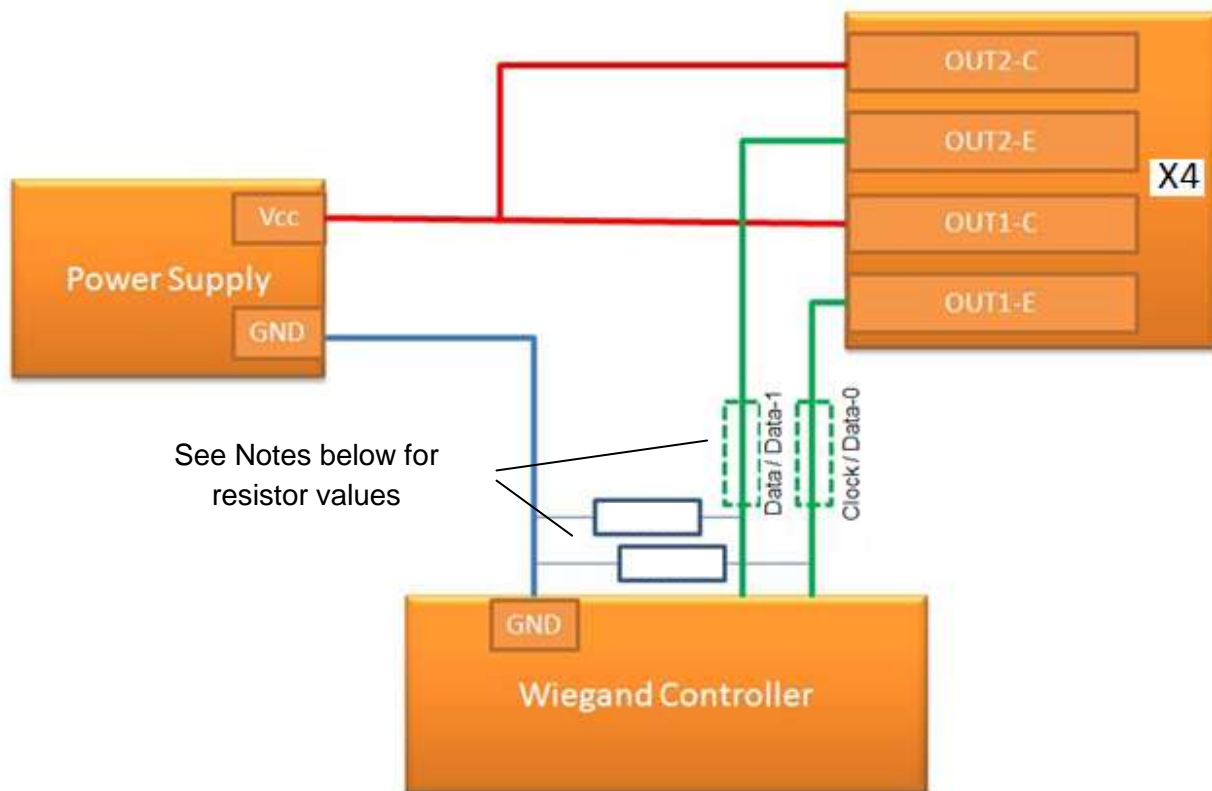

Figure 10: Wiring Example

**NOTE:**

*Please consider possible limitations of the Wiegand Controller regarding the used supply voltage.*

*The necessity of the external pull down resistor is depending on the inner circuit of the used Wiegand Controller*

*In dependency on the inner circuit of the used Wiegand Controller it is necessary to use external serial resistors to limit the current on the data and clock wires.*



---

#### 4.4. Inputs and Outputs on connector X4

---

##### 4.4.1. 24 V DC voltage on connector X4

---

A 24 V DC voltage can be received on Pin 4 of connector X4. It can be used e.g. to drive the digital Inputs and Outputs of the reader.

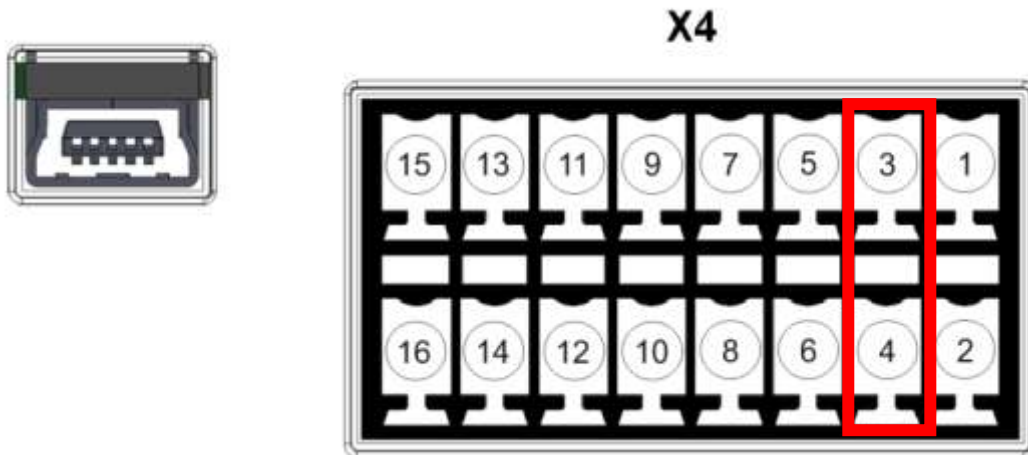

Figure 11: 24 V DC Voltage

Table 9: Pin Assignment 24 V DC Voltage

Pin Number at Connector X4	Pin Assignment
3	GND
4	24 V DC

**CAUTION:**

*The maximum current is limited to 750 mA.*

4.4.2. Digital Inputs on connector X4

The optocouplers on Terminal X4 are galvanically isolated from the Reader electronics and must therefore be externally supplied.

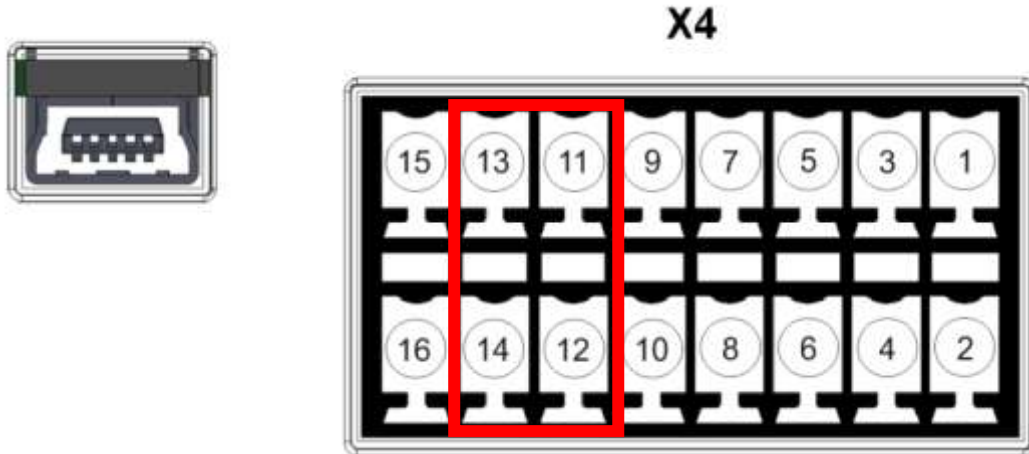

Figure 12: Digital inputs IN1 / IN2

Table 10: Pin Assignment digital Inputs IN1 / IN2

Pin Number at Connector X4	Pin Assignment
11	IN1 -
12	IN1 +
13	IN2 -
14	IN2 +

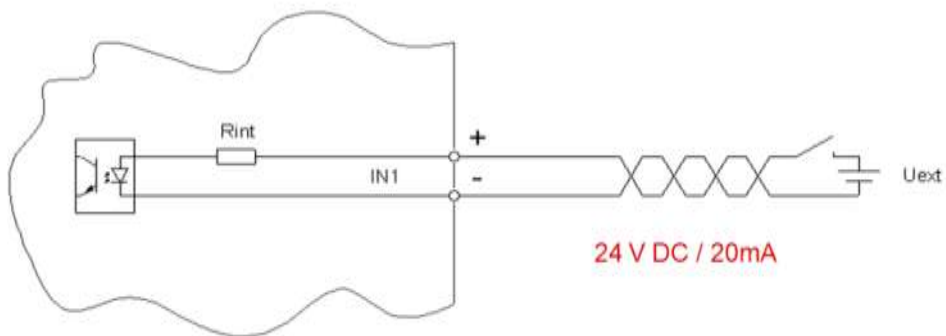

Figure 13: Internal and external wiring of the digital inputs IN1 / IN2

**NOTE:**

*The inputs are configured for a input voltage of 12 - 24 V DC and an input current of max. 20 mA.*

*Polarity reversal or overload on the input will destroy it.*

#### 4.4.3. Digital outputs on connector X4

The transistor connections, collector and emitter, of the optocoupler output are galvanically isolated from the Reader electronics and are carried to the outside without any internal ancillary circuitry on Terminal X4. The output must therefore be powered by an external power supply.

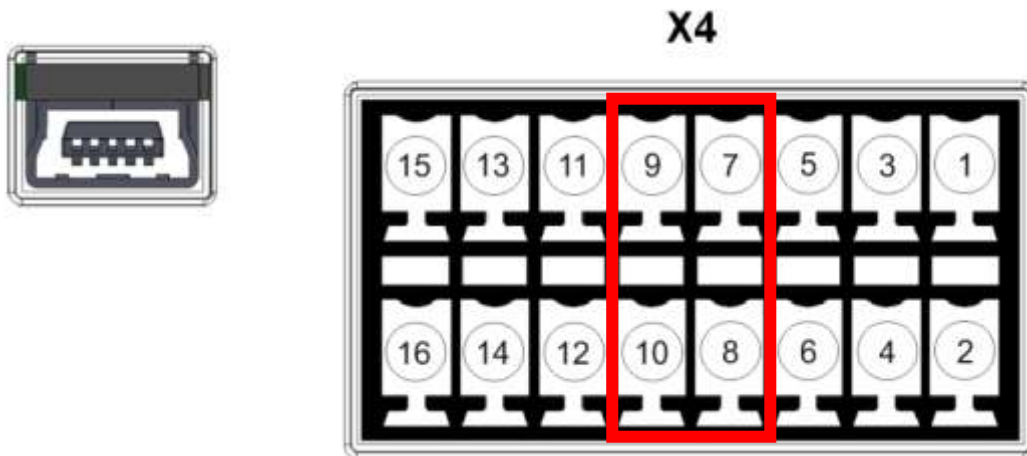

Figure 14: Digital outputs OUT1 / OUT2

Table 11: Pin Assignment digital outputs OUT1 / OUT2

Pin Number at Connector X4	Pin Assignment
7	OUT1-E
8	OUT1-C
9	OUT2-E
10	OUT2-C

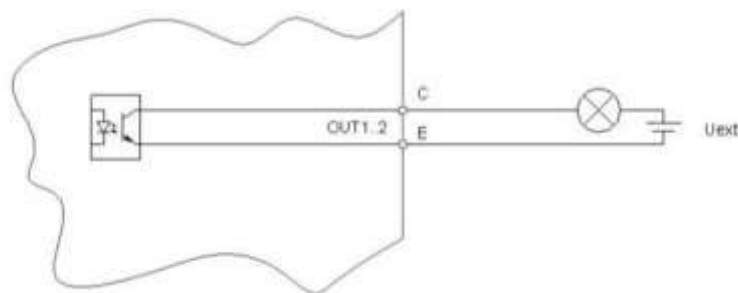

Figure 15: Internal and external wiring of the digital outputs OUT1 / OUT2

**CAUTION:**

*The output is configured for max. 24 V DC / 20 mA.*

*Polarity reversal or overload on the output will destroy it.*

*The output is intended for switching resistive loads only.*

4.4.4. Relay output on connector X4

There are 2 relay outputs (normally open) available on connector X4.

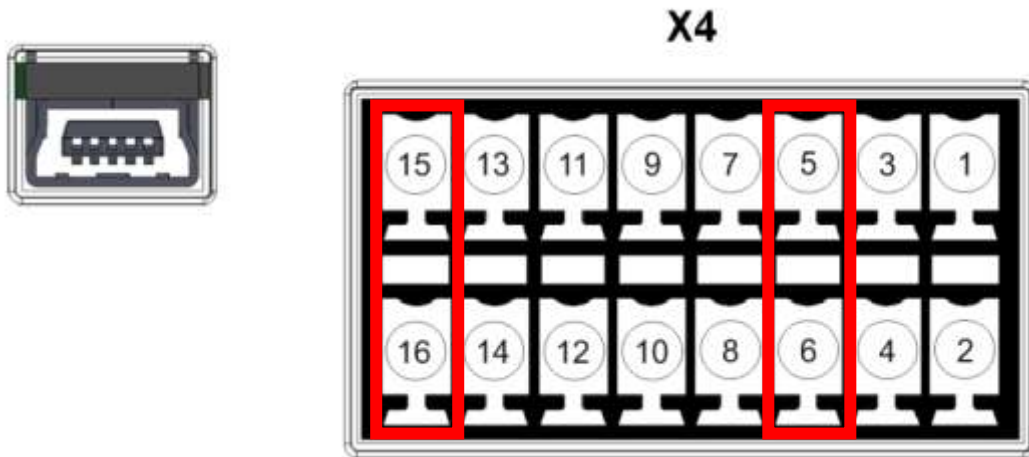

Figure 16: Relay outputs REL1 / REL2

Table 12: Pin Assignment Relay Outputs REL1 / REL2

Pin Number at Connector X4	Pin Assignment
5	REL1-NO
6	REL1-COM
15	REL2-NO
16	REL2-COM

**CAUTION:**

*The relay outputs are configured for max. 24 V DC / 2 A constant load.*

*The switching current must not exceed 1A.*

*The relay outputs are intended for switching resistive loads only. If an inductive load is connected, the relay contacts must be protected by means of an external protection circuit.*

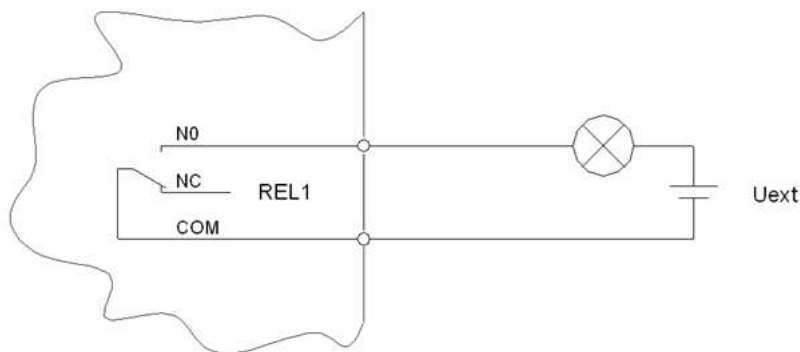
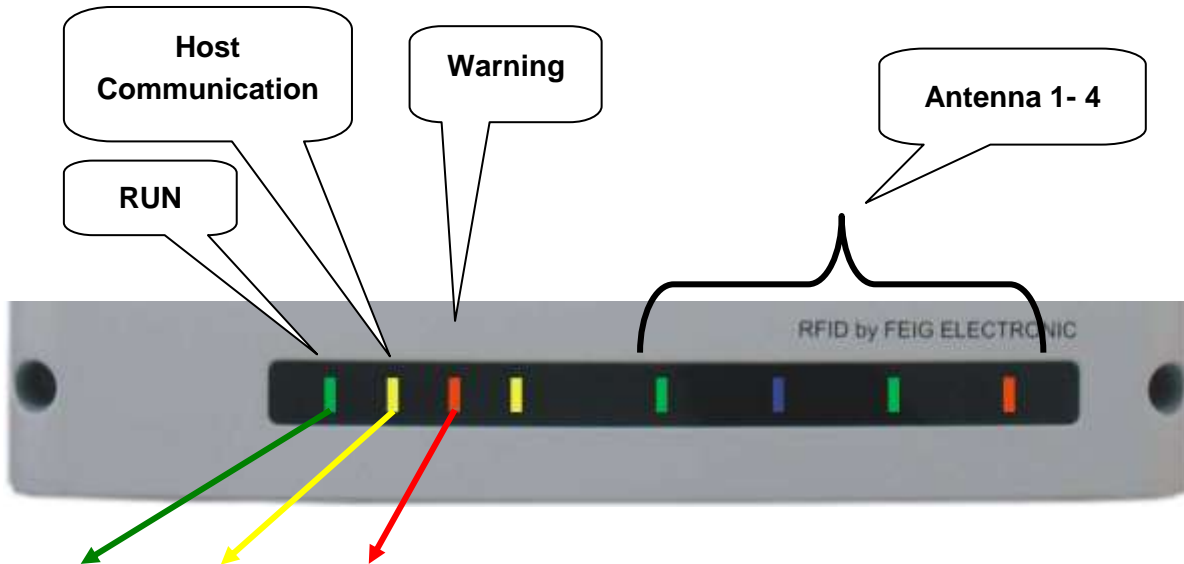

Figure 17: External wiring of the relay outputs

## 5. Operating and Display Elements

### 5.1. Status LED

Table 13: Configuration of the LED



Green	Yellow	Red	Description
FLASH	-	OFF	Normal Reader operation
FLASH	FLASH	OFF	Reader receives a valid protocol from host
FLASH	-	ON	RF Warning [0x84]
FLASH (alternating)	-	FLASH (alternating)	Hardware Warning; perform Reader Diagnostic [0x6E] for further information
<b>Firmware Update:</b>			
FLASH (light in sequence)	FLASH	FLASH	Firmware transfer from host to reader (Please do not switch off the reader or disconnect the interface cable)
<b>Configurations-Reset:</b>			
FLASH (light in sequence)	FLASH	FLASH	While T1 is pushed and hold for maximal 5 s
ON	ON	ON	After T1 has been pushed and hold for 5 s complete configuration reset has been performed
<b>ANT 1 – 4:</b>			
<b>Green</b>			HF Power switched on
<b>Blue</b>			Transponder detected
<b>Red</b>			Antenna impedance error (unequal 50 Ohm)

---

## 5.2. Reset Push Button T1

---

By means of the push button T1 a complete configuration reset can be performed. The push button is positioned in the middle between the antenna connectors ANT3 and ANT4. Figure 18 shows the position of the push button. It is located inside the reader housing. To press the reset button T1 you should use a paper clip.

To reset the reader back to factory default push the button for at least 5 s until the 3 status LED (left side) are switched on continuously. After releasing the push button the reader performs a re-start.

During a complete configuration reset all parameters of the reader will be reset back to factory default and need to be configured again.

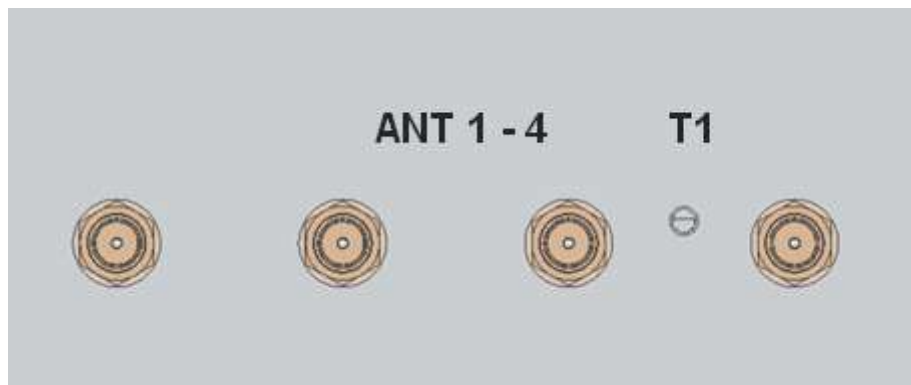

Figure 18: Position of the reset button T1

### 5.3. Reader Power Adjustment

To achieve the optimum reading performance it is necessary to set the reader output power to the highest allowed value. This depends on the used reader type (EU / FCC) and the regulation in the country where the reader is used.

#### 5.3.1. EU reader according to EN 302 208

According to the standard EN 302 208 the maximum radiated power is 2 W e.r.p. (Effective Radiated Power) in countries of the European Union. The in the reader configured output power  $P_{out}$  depends on the antenna gain in dBi and the attenuation of the antenna cable. If a circular polarized antenna is used the antenna gain [dBic] can be reduced by 3dB. At a linear polarized antenna the maximum linear antenna gain [dBi] must be used.

$$P_{Out} = P_{erp} - \text{Antenna Gain} + \text{Cable loss} + 2,1\text{dB}^{**}$$

\*\* Correction Factor to convert the radiated power from e.r.p to e.i.r.p.

For the calculation of the reader output power  $P_{Out}$  an Excel file „Calc-RF-Power.xls“ can be used. Available from Feig Electronic GmbH.

Example:

Radiated Power		2,0 W [e.r.p]	<>	33,0 dBm
correction factor ERP-> EIRP	*	1,64	+	2,1 dB
Radiated Power Isotrop	=	3,28 W [e.i.r.p]	=	35,1 dBm
Antenna Gain		11,0 dBic	-	11,0 dBi
Typ of antenna **		1	3	+ 3,0 dB
cable losses / 100m		30,7 dB		
cable losses / 1m		0,3 dB		
Length of the antenna cable	*	6 m		
	=	1,8 dB	+	1,8 dB
<b>Radiated power in dB</b>				<b>29,0 dBm</b>
<b>Output power in mW</b>				<b>786 mW</b>
<b>Configuration in the Reader (CFG3)</b>			<=	<b>0,8 W</b>

\*\* linear antenna = „0“, circular antenna = „1“

Figure 19: Calculation of the output power

In Figure 19 the allowed antenna power is shown for the use of the FEIG standard antenna ANT.U600/270 –EU and a 6m long Belden H155 coaxial cable.

---

### 5.3.2. FCC Reader according to FCC 47 Part 15

---

According to the FCC approval, Title 47, Part15 the maximum output power of the reader is limited to 1 W (30dBm). The maximum radiated power of the antenna should not increase more than 4 W e.i.r.p. Due to these facts the antenna ID ISC.ANT.U600/270-FCC (7,5 dBi) must be used with at least 5,0 m of cable type Belden H155 (0,3 dB/m) or at least 3,0 m of cable type RG58 (0,5 dB/m).

Antenna Type	Permitted Cable
ID ISC.ANT.U600/270-FCC	Min. 5,0 m of cable type Belden H155 (0,3 dB/m) or min. 3,0 m of cable type RG58 (0,5 dB/m)
ID ISC.ANT.U270/270-FCC	-/-



---

## 6. Technical Data

---

### MECHANICAL DATA

---

Housing	Aluminum powder-coated
Dimension (W x H x D)	260 mm x 157 mm x 68 mm 10.2 inch x 6.2 inch x 2.7 inch
Weight	1,8 kg (4.0 lb)
Protection Class	IP 53 (with protection cap IP64)
Colour	RAL 9003 (Signal White)

### ELECTRICAL DATA

---

Power Supply	24 V DC $\pm$ 20 % (Noise Ripple: max. 150 mV)
Current Consumption	max. 3,8 A typ.* 1,0 A  *without the power consumption of an external connected device, like a UHF –Multiplexer
Operating Frequency	
<ul style="list-style-type: none"> <li>• EU-Reader</li> <li>• FCC-Reader</li> </ul>	865 MHz to 868 MHz (EN 302 208) 902 MHz to 928 MHz (FCC47 Part15)
RF-Power	100 mW up to max. 2 W configurable (Tolerance: max. $\pm$ 3 dB)
Antenna Connection	4 x SMA female (50 $\Omega$ ), internal Multiplexer, configurable with 24 V DC $\overline{\text{---}}$ / max. 500 mA on the antenna output
RF-Diagnostic	RF-Channel monitoring Antenna SWR-monitoring Internal Overheating control*
Outputs	
<ul style="list-style-type: none"> <li>• 2 x Optocoupler</li> <li>• 2 x Relay (NOC)</li> </ul>	24 V DC $\overline{\text{---}}$ / 20 mA (galvanically isolated) 24 V DC $\overline{\text{---}}$ / 1 A (switching current), (2A constant load)
Inputs	
<ul style="list-style-type: none"> <li>• 2 x Optocoupler</li> </ul>	max. 12 - 24 V DC $\overline{\text{---}}$ / 20 mA

\* Caution: Overheating of the device may result in performance losses. It is recommended to activate the RF of the reader only if there is a transponder in the detection range of an antenna.

Interfaces	RS232 USB Mini (USB 2.0; Full Speed; On-The-Go) Ethernet (10/100 BASE-T; MDI/MDI-X cross over detection; IPv4) Wiegand (Scan Mode Schnittstelle)
------------	---

## FUNCTIONAL PROPERTIES

---

Protocol Modes	FEIG ISO HOST Mode (Advanced Protocol Frame) Buffered Read Mode <i>Automatic Data</i> Scan Mode <i>Buffering and</i> Notification Mode <i>Filtering</i>
Supported Transponder Types	EPC Class 1 Generation 2 ISO 18000-6-C (Upgrade Code required) Further transponder types on request possible
Optical Indicators	16 LEDs for analyze the operating status and the connected antennas
Further Features	Anticollision Output of RSSI and Phase Angle RF-Channel monitoring Support of enciphered transponder communication Secure key memory “Config Cloning“-function Real-time clock (Battery-buffered)

## AMBIENT CONDITIONS

---

Temperature Range	
• Operation	-25 °C up to +55 °C
• Storage	-25 °C up to +85 °C
Humidity	5 % up to 95 % non-condensing
Vibration	EN 60068-2-6 10 Hz to 150 Hz: 0,075 mm / 1 g
Shock	EN 60068-2-27 Acceleration 30 g

**APPLICABLE STANDARDS**

---

## Radio Regulation

- Europe EN 302 208
- USA FCC 47 CFR Part 15
- Canada IC RSS-210

## EMC

EN 301 489

## Safety

- Low Voltage EN 62368-1
- Human Exposure EN 50364

---

## 7. Radio Approvals

---

---

### 7.1. Europe (CE)

---

Hereby, FEIG ELECTRONIC GmbH declares that the radio equipment type ID ISC.LRU1002 is in compliance with Directive 2014/53/EU.

The full text of the EU declaration of conformity is available at the following internet address:

<http://www.feig.de/en/downloads-support/declarations-of-conformity.html>



Performance Classification according to ETSI EN 301 489: Class 2

---

**7.2. USA (FCC) and Canada (IC)**

---



---

**7.2.1. USA (FCC) and Canada (IC) warning notices**

---

<b>Product name:</b>	<b>ID ISC.LRU1002-FCC</b>
<b>FCC ID:</b> <b>IC:</b>	<b>PJMLRU1002A</b> <b>6633A-LRU1002A</b>
<b>Notice for USA and Canada</b>	<p>This device complies with Part 15 of the FCC Rules and with RSS-210 of Industry Canada.</p> <p>Operation is subject to the following two conditions.</p> <p>(1) this device may not cause harmful interference, and</p> <p>(2) this device must accept any interference received, including interference that may cause undesired operation.</p> <p>Unauthorized modifications may void the authority granted under Federal communications Commission Rules permitting the operation of this device.</p> <p>This equipment has been tested and found to comply with the limits for a Class A digital device, pursuant to Part 15 of the FCC Rules. These limits are designed to provide reasonable protection against harmful interference when the equipment is operated in a commercial environment. This equipment generates, uses, and can radiate radio frequency energy and, if not installed and used in accordance with the instruction manual, may cause harmful interference to radio communications. Operation of this equipment in a residential area is likely to cause harmful interference in which case the user will be required to correct the interference at his own expense.</p> <p>Le présent appareil est conforme aux CNR d'Industrie Canada applicables aux appareils radio exempts de licence. L'exploitation est autorisée aux deux conditions suivantes :</p> <p>(1) l'appareil ne doit pas produire de brouillage, et</p> <p>(2) l'utilisateur de l'appareil doit accepter tout brouillage radioélectrique subi, même si le brouillage est susceptible d'en compromettre le fonctionnement.</p>

**Warning:**

***Changes or modification made to this equipment not expressly approved by FEIG ELECTRONIC GmbH may void the FCC authorization to operate this equipment.***

---

### 7.2.2. Label Information

---

The following information must be placed at the outer side of the housing in which the reader is mounted.

**Contains FCC ID PJMLRU1002A**  
**Contains IC: 6633A-LRU1002A**

---

### 7.2.3. Installation with FCC / IC Approval

---

FCC-/IC-NOTICE: To comply with FCC Part 15 Rules in the United States / with IC Radio Standards in Canada, the system must be professionally installed to ensure compliance with the Part 15 certification / IC certification. It is the responsibility of the operator and professional installer to ensure that only certified systems are deployed in the United States / Canada.

---

### 7.2.4. USA (FCC) and Canada (IC) approved antennas

---

This radio transmitter (identify the device by certification number, or model number if Category II) has been approved by Industry Canada to operate with the antenna types listed below with maximum permission gain and required antenna impedance for each antenna type indicated. Antenna types, not included in this list, having a gain greater than the maximum gain indicated for that type, are strictly prohibited for use with this device.

The antennas used for this transmitter must be installed to provide a separation distance of at least 34 cm from all persons and must not be located or operating in conjunction with any other antenna or transmitter, except as listed for this product's certification.

Le présent émetteur radio (identifier le dispositif par son numéro de certification ou son numéro de modèle s'il fait partie du matériel de catégorie I) a été approuvé par Industrie Canada pour fonctionner avec les types d'antenne énoncé ci-dessus et ayant un gain admissible maximal et l'impédance requise pour chaque type d'antenne. Les types d'antenne non inclus dans cette liste, ou dont le gain est supérieur au gain maximal indiqué, sont strictement interdits pour l'exploitation de l'émetteur.

Les antennes utilisées pour cet émetteur doit être installé pour fournir une distance de séparation d'au moins 34 cm de toutes les personnes et ne doit pas être situé ou opérant en conjonction avec une autre antenne ou un autre émetteur, sauf dans les cas énumérés à la certification de ce produit.

Following antennas are approved by FCC according FCC Part 15 and IC Canada according RS210

- ID ISC.ANT.U270/270-FCC (6.0 dBi)
- ID ISC.ANT.U600/270-FCC (7,5 dBi)

**ANNEX A - Accessories**

Following optional accessories are available:

Order No.	Article	Description
3558.000.00	ID ISC.LR.CSC-IP64 Connector Sealing Cap	Plastic Sealing Cap for Reader Connectors with Steel Conduit Pipe Thread (PG) for ID ISC.LRU3x00 and ID ISC.LRU1002 
3831.000.00	ID ISC.LRU3x00-MS Mounting Rail Set	Mounting Rail Set for ID ISC.LRU3x00 and ID ISC.LRU1002
EU: 3198.000.00 FCC: 3685.000.00	ID ISC.ANT.U600/270 UHF Antenna	UHF Antenna for connection to UHF Reader, Connector: RG58 coax cable 10 cm, plug SMA – female, 3dB beamwidth 65° x 30°
EU: 3199.000.00 FCC: 3686.000.00	ID ISC.ANT.U270/270 UHF Antenna	UHF Antenna for connection to UHF Reader, Connector: SMA – female, 3dB beamwidth 65° x 65°
EU: 3200.000.00	ID ISC.ANT.U170/170 UHF Antenna	UHF Antenna for connection to UHF Reader, Connector: RG316/U coax cable 10 cm, plug SMA – female, 3dB beamwidth 85° x 85°
3308.000.00	ID ISC.ANT.U600/270-MS Mounting Set Antenna UHF	Mounting Set for UHF Antenna ID ISC.ANT.U600/270. Suitable for mounting on installation pipes with a diameter of up to 60 mm.
3309.000.00	ID ISC.ANT.U270/270-MS Mounting Set Antenna UHF	Mounting Set for UHF Antenna ID ISC.ANT.U270/270. Suitable for mounting on installation pipes with a diameter of up to 60 mm.
3310.000.00	ID ISC.ANT.U170/170-MS Mounting Set Antenna UHF	Mounting Set for UHF Antenna ID ISC.ANT.U170/170. Suitable for mounting on installation pipes with a diameter of up to 60 mm.
1654.002.00	ID ISC.ANT.C2-A UHF Antenna Cable 2m	H155 Coax Cable for UHF Reader, Connection Plug SMA - male/male, Length: approx. 2 m
1654.003.00	ID ISC.ANT.C6-A UHF Antenna Cable 6m	H155 Coax Cable for UHF Reader, Connection Plug SMA - male/male, Length: approx. 6 m
2557.000.00	ID NET.24V-B Power Supply Unit	Power Supply Unit for ID ISC.LR/LRM2500/1002, ID ISC.LRU/LRU3x00/1002. Versatile outlets available (EU, GB, US - not included).
2558.000.00	ID CAB.NET.24V-B-EU Cable with European Plug	Cable with Continental European Plug for Power Supply Unit ID NET.24V-B
2559.000.00	ID CAB.NET.24V-B-GB Cable with GB/UK Plug	Cable with GB Plug for Power Supply Unit ID NET.24V-B
2560.000.00	ID CAB.NET.24V-B-US Cable with US Plug	Cable with US Plug for Power Supply Unit ID NET.24V-B
4104.000.00	ID CPR.USB/OTG USB Stick + On-The-Go Adapter Cable	4 GB USB Flash Drive incl. USB On-The-Go Adapter Cable